

**Smart Pumps for  
pressure boosting**

**50 Hz**



## SMART PUMP RANGE e-HME & e-SVE Series

PERMANENT MAGNET MOTOR WITH EMBEDDED DRIVE  
AND HIGH EFFICIENCY HYDRAULICS

# Smart Pump range

Smart Pumps are not only smart. They're smooth. They operate steadily in partial loads, which prevents the water hammer that's normally associated with full speed pumps. What's more, their accurate speed control during operation and their smooth start-up reduce mechanical stress and wear.

Available in single phase from 0.37 to 1.5 kW, Smart Pumps are easy to commission, set up and operate using the simple start-up menu. Parameters and alarms appear on an easy-to-read display designed to provide complete control of system operation. They're easy to program too, with just three keypad touches.

Each Smart Pump features an IE5 motor for best-in-class efficiency and enhanced hydraulic performance. The range has an IP55 enclosure rate, and includes BACnet and Modbus capability for seamless building management system integration in all stand-alone configurations. The drive is suitable for installations from -20°C to 50°C without power derating.

## APPLICATIONS

- Water boosting supply systems in residential buildings and homes
- Irrigation small to medium
- Light industrial
- Air conditioning
- Water treatment plants

### e-SVE

Vertical multistage stainless steel pumps



### e-HME

Horizontal multistage pumps



# **e-HME**

## **Version with drive and permanent magnet motor (e-SM Drive)**



## e-HME SERIES e-HM SMART SERIES

### Background and context

In every sector, from construction and industry to agriculture and building services the need for intelligent, compact and high-efficiency pumping systems is constantly growing. That's why Lowara has developed the e-HME series: an integrated intelligent pumping system with electronically driven, permanent magnet motor (IE5 efficiency level). The integrated control system, combined with the high performance, power and efficiency from the motor and hydraulics, guarantees impressively low operating costs. You also benefit from flexibility, precision and its ultra-compact size.

### Savings

The electronics and permanent magnet motor are highly efficient and minimize power losses while transferring maximum energy to the hydraulic parts of the pump. The refined control system with integrated microprocessor adjusts the motor speed, matching the required operating point of the pump or system requirements. This reduces demand on electricity according to the required working conditions. This creates economies, especially in systems where pump demand varies over time.

### Flexibility

The compact size, low loss and increased control make the e-HM Smart series a good choice in applications and systems where fixed speed pumps are commonly used. The e-HM Smart series is easy to integrate in control and regulation loops thanks to the wide availability of compatible communication protocols, including analog and digital inputs. The pump is supplied with a pressure sensor.

### Ease of use and commissioning

e-HM Smart has an intuitive interface that guides the user through the installation, and a practical area to assist with connections. The control system is integrated and no additional external electrical panel is required.

### Application sectors

- Water supply systems in residential buildings
- Air conditioning
- Water treatment plants
- Industrial installations



### e-SM System

- 230V +/- 10% single phase power supply, 50/60 Hz
- Power up to 1,5 kW
- Protection class IP55
- Can be linked up to 3 e-HM Smart pumps

### Pump

- Flow rate: up to 29 m<sup>3</sup>/h
- Head: up to 152 m
- Environment temperature: -20°C to +50°C with no performance derating
- Temperature of pumped liquid: up to +120°C for single-phase motor versions
- Maximum operating pressure 16 bar (PN 16)
- The hydraulic performances meet the tolerances specified in ISO 9906:2012

### Motor

- IE5 efficiency level (IEC TS 60034-30-3:2016)
- Synchronous electric motor with permanent magnets, (TEFC), closed structure, air-cooled
- Insulation class 155 (F)
- Overload protection and locked rotor with automatic reset incorporated

## e-HME SERIES e-HM SMART SERIES

e-HM Smart series is equipped with an intelligent control that optimizes hydraulic performance while minimizing waste.

**Integrated intelligence:** The electronic control of the motor enables a 20% increase in performance compared to an equivalent fixed speed pump (area highlighted in figure "Integrated intelligence").

**Adjustment:** This is possible both at constant pressure and according to the characteristic curve of the system, based on the customer's preferences. Another option is according to an external signal or at a preset speed.

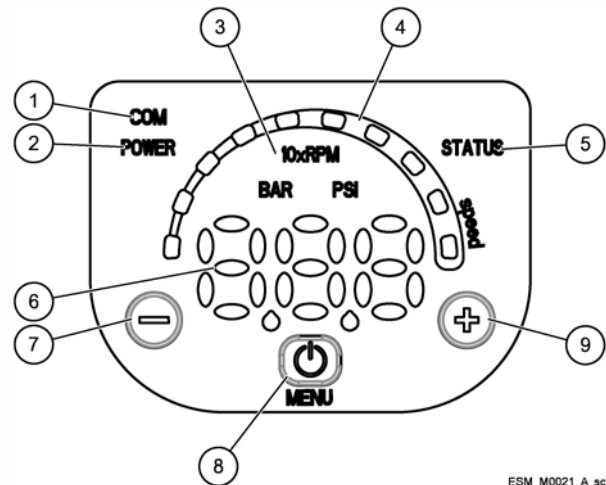

ESM\_M0021\_A\_sc

**Intuitive and simple interface:** You can control the unit from just three buttons, with an easy to read display for parameters and alarms, designed for complete control of system operation.

- ① Communication LED
- ② Power on LED
- ③ Unit of measure LED
- ④ Speed LED bar
- ⑤ Status LED
- ⑥ Numeric display
- ⑦ ⊖ Decrease key
- ⑧ ⏻ On/off and menu key
- ⑨ ⊕ Increase key

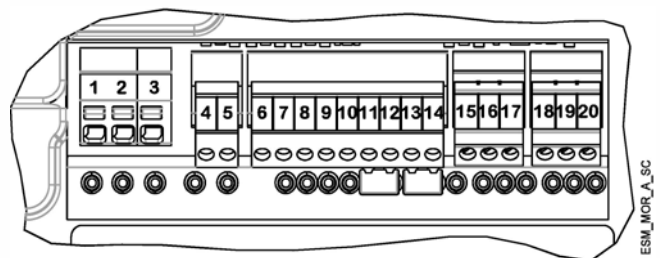
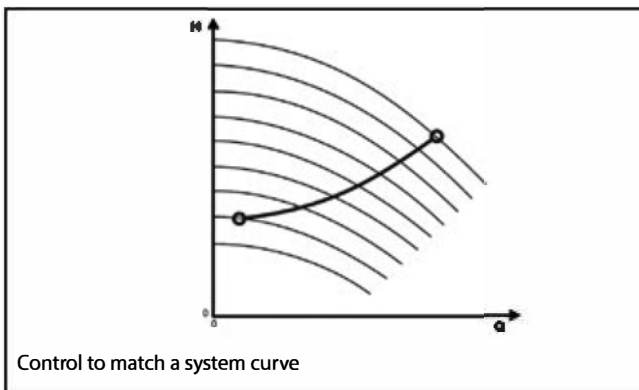
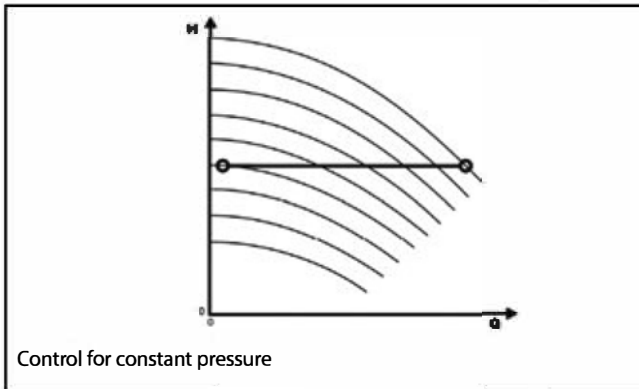
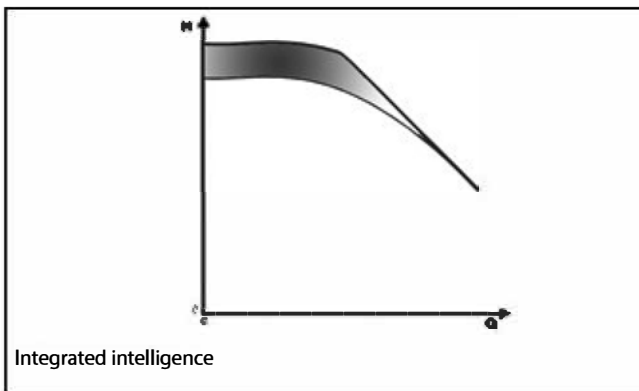

ESM\_M0R\_A\_sc

### Terminal block

e-HM Smart has the following terminals:

- 1, 2, 3 = Power supply (⊕, L, N)
- 4, 5 = Fault signal (NO) - (Ext  $V_{max} < 250 \text{ VAC}$  -  $I_{max} < 2\text{A}$ )
- 6 = Auxiliary voltage supply +15 VDC
- 7, 8 = Analog 0-10V
- 9 = Power supply external sensor +15 VDC
- 10 = External sensor 4-20 mA input
- 11, 12 = External start/stop
- 13, 14 = External lack of water
- 15, 16, 17 = Communication bus RS485, protocol Modbus and BACnet
- 18, 19, 20 = Communication bus RS485, enabled via dedicated module

**e-HME SERIES**  
**HOW TO READ SMART PUMP SERIES CURVES**

To exploit to the maximum potential of Smart Pumps it's important to properly read working curves:

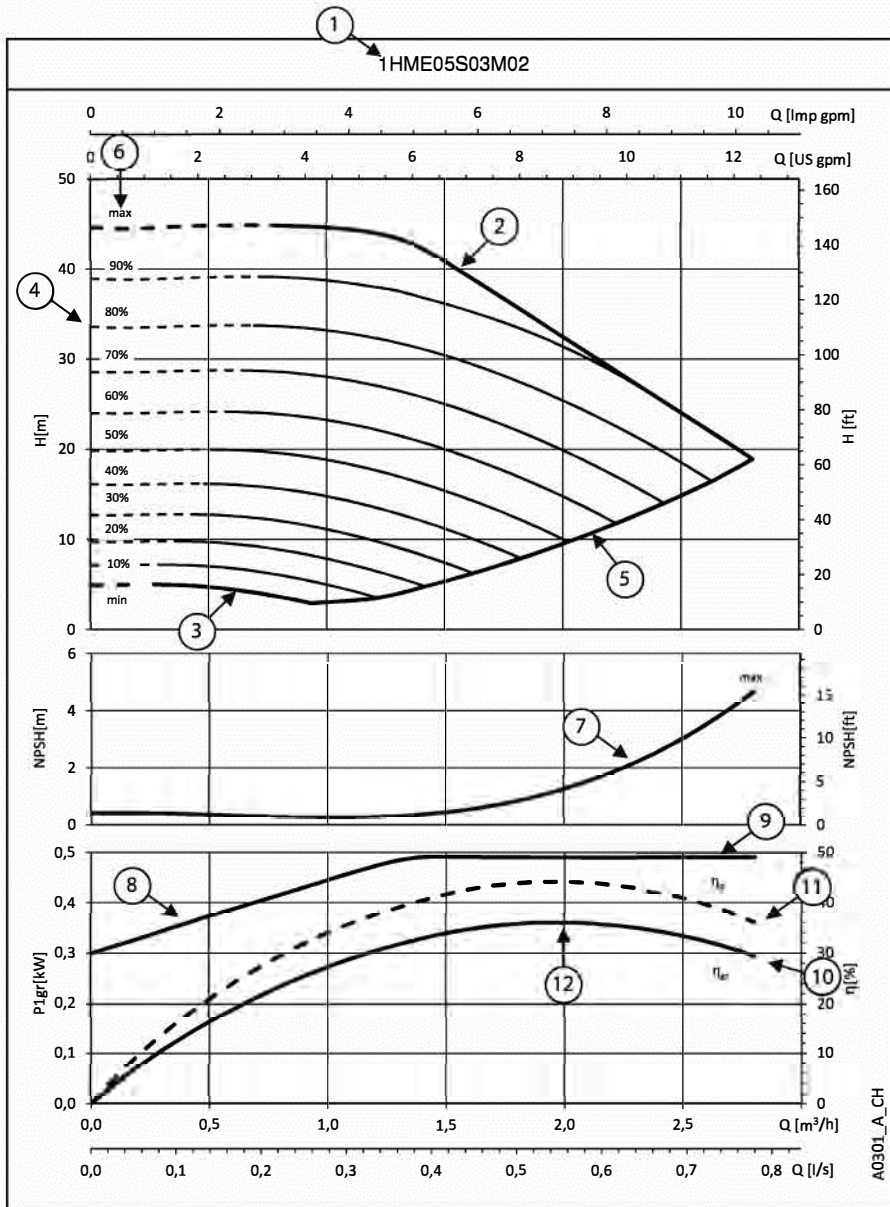

① **Pump model**

② **Maximum speed curve:** equal to 3600 rpm

③ **Minimum speed curve:** it refers to the minimum rpm level the motor can work at, it's calculated depending on the model of pump maximizing for each one the working area and allowing the highest system flexibility.

④ The **area with dotted lines** is where the pump can only operate intermittently for short periods of time.

⑤ Each **intermediate curve** between max and min speed shows the percentage of load the pump+motor+drive system is working at; it's easy to read also from the LED speed bar on the HMI keypad: at 90% there will be 9 led, at 80% there will be 8 and so on.

Example: at 60% there will be 6 lit led's

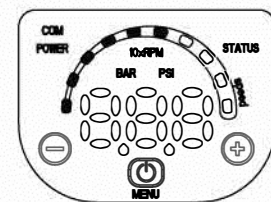

⑥ The **part load percentage** is calculated depending on maximum speed (*max*, 100%) and minimum speed (*min*, equal to 0%, which is the minimum part load step, below it the drive stays powered up but cannot work).

⑦ **NPSH**: is the net positive suction head of pump+motor+drive system working at maximum speed.

⑧ **P1<sub>gr</sub>** is the power absorption in kW of pump+motor+drive system working at maximum speed.

⑨ **Load control**: the Smart Pump controls and limits power consumption at high flow/low head, in this way the motor stays protected from overload and ensure a longer life of pump+motor+drive system.

⑩  **$\eta_{gr}$**  is the efficiency of pump+motor+drive system working at maximum speed.

⑪  **$\eta_p$**  is the efficiency of the hydraulic part, working at maximum speed.

⑫ **Working point**: it's important to make sure the pump is working at the best working point, the one at highest efficiency. It's easy to find it: it's the highest point of the  $\eta_p$  pump efficiency curve; once you found it, you can learn also flow values from x-axis called Q and head values from y-axis called H which allow the system to work at the best working point.

## 1, 3, 5, 10, 15HME..S SERIES HYDRAULIC PERFORMANCE TABLE

PUMP TYPE HME..S, HME..N Single-phase	MOTOR		e-SM SET		Q = DELIVERY							
	P <sub>N</sub> kW	TYPE 1x230 V	* P <sub>1</sub> kW	* I 208-240 V A	l/min 0	6,7	13,3	20,0	26,7	33,3	40,0	46,7
					m <sup>3</sup> /h 0	0,4	0,8	1,2	1,6	2,0	2,4	2,8
H = TOTAL HEAD IN METRES OF COLUMN OF WATER												
1HME05S03M02	0,37	ESM80/103 HM..	0,49	2,24	44,7	44,8	44,9	44,1	39,2	32,5	25,7	
1HME08S05M02	0,55	ESM80/105 HM..	0,69	3,07	71,6	71,5	71,7	70,4	60,3	50,0	39,6	
1HME11S07M02	0,75	ESM80/107 HM..	0,91	4,04	98,5	98,5	98,8	94,3	80,7	66,8	52,9	
1HME15S11M02	1,1	ESM80/111 HM..	1,33	5,85	134,0	134,4	134,6	132,3	119,5	99,5	79,6	
1HME17S15M02	1,5	ESM80/115 HM..	1,77	7,77	151,8	152,2	152,7	149,6	141,6	128,6	110,7	

PUMP TYPE HME..S, HME..N Single-phase	MOTOR		e-SM SET		Q = DELIVERY							
	P <sub>N</sub> kW	TYPE 1x230 V	* P <sub>1</sub> kW	* I 208-240 V A	l/min 0	13,3	26,7	40,0	53,3	66,7	80,0	86,7
					m <sup>3</sup> /h 0	0,8	1,6	2,4	3,2	4,0	4,8	5,2
H = TOTAL HEAD IN METRES OF COLUMN OF WATER												
3HME03S03M02	0,37	ESM80/103 HM..	0,49	2,24	33,3	33,9	33,4	31,5	25,6	20,1	14,6	11,8
3HME05S05M02	0,55	ESM80/105 HM..	0,69	3,07	55,5	56,5	55,7	47,5	38,2	29,4	20,5	16,0
3HME07S07M02	0,75	ESM80/107 HM..	0,91	4,06	77,6	79,1	78,1	64,9	52,0	39,8	27,5	21,3
3HME09S11M02	1,1	ESM80/111 HM..	1,33	5,85	99,8	101,8	100,3	93,6	76,1	59,6	43,0	34,7
3HME12S15M02	1,5	ESM80/115 HM..	1,78	7,80	133,1	135,9	133,6	127,3	103,6	81,5	59,2	48,1

PUMP TYPE HME..S, HME..N Single-phase	MOTOR		e-SM SET		Q = DELIVERY							
	P <sub>N</sub> kW	TYPE 1x230 V	* P <sub>1</sub> kW	* I 208-240 V A	l/min 0	23,3	46,7	70,0	93,3	116,7	140,0	170,0
					m <sup>3</sup> /h 0	1,4	2,8	4,2	5,6	7,0	8,4	10,2
H = TOTAL HEAD IN METRES OF COLUMN OF WATER												
5HME02S03M02	0,37	ESM80/103 HM..	0,49	2,24	22,2	22,4	21,9	19,8	16,2	13,0	9,9	6,0
5HME03S05M02	0,55	ESM80/105 HM..	0,69	3,07	33,3	33,6	32,9	29,5	24,1	19,3	14,7	8,8
5HME04S07M02	0,75	ESM80/107 HM..	0,91	4,05	44,4	44,7	43,8	40,1	32,8	26,4	20,2	12,2
5HME06S11M02	1,1	ESM80/111 HM..	1,33	5,85	66,7	67,2	65,8	59,0	48,1	38,7	29,5	17,5
5HME08S15M02	1,5	ESM80/115 HM..	1,78	7,82	88,9	89,5	87,7	80,2	65,5	52,8	40,4	24,4

PUMP TYPE HME..S, HME..N Single-phase	MOTOR		e-SM SET		Q = DELIVERY							
	P <sub>N</sub> kW	TYPE 1x230 V	* P <sub>1</sub> kW	* I 208-240 V A	l/min 0	40,0	80,0	120,0	160,0	200,0	240,0	283,3
					m <sup>3</sup> /h 0	2,4	4,8	7,2	9,6	12,0	14,4	17,0
H = TOTAL HEAD IN METRES OF COLUMN OF WATER												
10HME01S07M02	0,75	ESM80/107 HM..	0,86	3,80	17,5	17,5	17,0	16,1	14,7	12,7	10,2	6,6
10HME02S11M02	1,1	ESM80/111 HM..	1,33	5,85	34,8	34,9	33,8	32,3	27,2	21,9	16,6	11,1
10HME03S15M02	1,5	ESM80/115 HM..	1,78	7,81	52,4	51,8	50,6	46,9	39,2	32,2	25,3	17,8

PUMP TYPE HME..S, HME..N Single-phase	MOTOR		e-SM SET		Q = DELIVERY							
	P <sub>N</sub> kW	TYPE 1x230 V	* P <sub>1</sub> kW	* I 208-240 V A	l/min 0	70,0	140,0	210,0	280,0	350,0	420,0	483,3
					m <sup>3</sup> /h 0	4,2	8,4	12,6	16,8	21,0	25,2	29,0
H = TOTAL HEAD IN METRES OF COLUMN OF WATER												
15HME01S11M02	1,1	ESM80/111 HM..	1,33	5,85	20,9	20,5	19,7	18,8	16,4	12,7	8,8	5,2
15HME02S15M02	1,5	ESM80/115 HM..	1,79	7,85	42,7	41,8	35,9	29,8	24,2	18,2	11,3	5,1

\* Maximum value in specified range: P<sub>1</sub> = input power; I = input current.

1-15hmes-esm-2p50-en\_a\_th

## ELECTRICAL DATA TABLE

P <sub>N</sub> kW	MOTOR TYPE	IEC SIZE	Construction Design	SPEED (RPM) min <sup>-1</sup>	INPUT CURRENT I (A) 208-240 V	DATA RELATED TO THE VOLTAGE OF 230V						IES
						In A	cosφ	Tn Nm	η % 4/4 3/4 2/4			
0,37	ESM80/103 HM..	80	SPECIAL	3000	2,28-1,99	2,08	0,95	1,18	81,3	79,1	74,3	2
				3600	2,30-2,02	2,10		0,98	80,6	77,5	72,0	
0,55	ESM80/105 HM..	80		3000	3,27-2,85	2,96	0,97	1,75	83,3	82,2	78,8	2
				3600	3,27-2,85	2,96		1,46	83,3	81,5	77,5	
0,75	ESM80/107 HM..	80		3000	4,43-3,84	4,00	0,98	2,39	83,3	83,3	81,5	2
				3600	4,38-3,79	3,94		1,99	84,5	83,5	80,6	
1,10	ESM80/111 HM..	80		3000	6,26-5,35	5,64	0,99	3,50	85,7	85,1	82,7	2
				3600	6,20-5,32	5,63		2,92	85,9	84,6	81,4	
1,50	ESM80/115 HM..	80		3000	8,57-7,32	7,69	0,99	4,77	85,6	85,7	84,7	2
				3600	8,42-7,25	7,62		3,98	86,3	85,9	84,0	

\* The indicated rotational speed are representing the upper and lower limits of the rated power operational speed range.

eHM-eVM\_Smart-motm\_en\_a\_th

In the range 3000-3600 rpm the nominal motor power is guaranteed. Above 3600 rpm it isn't possible work and the motor is automatically limited; below 3000 rpm it works partially load.

### 1, 3, 5HME..S SERIES DIMENSIONS AND WEIGHTS

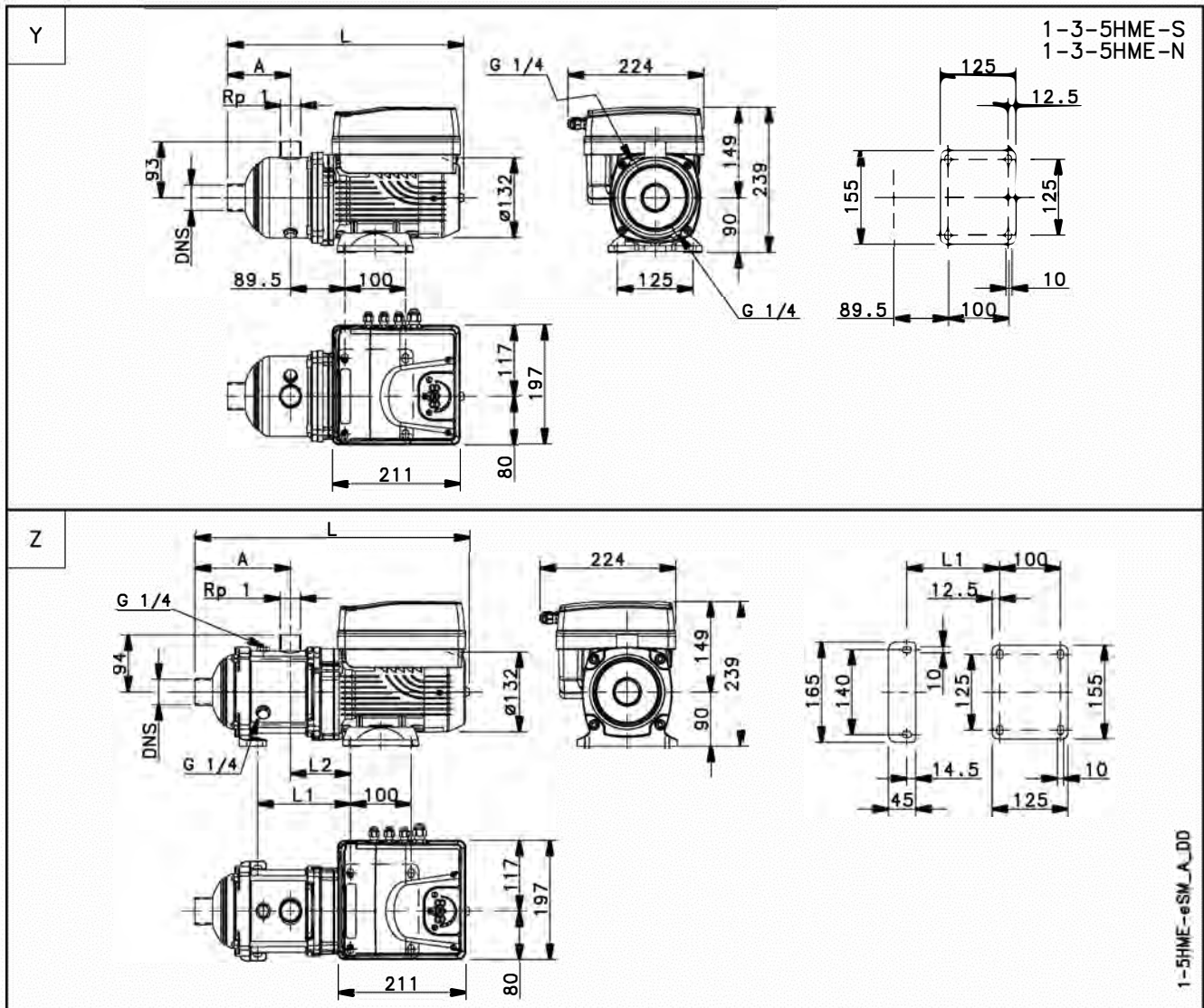

1-5HME-esm-2p50\_DD

PUMP TYPE	VERSION	Ref.	MOTOR		DIMENSIONS (mm)					PN	WEIGHT
			kw	SIZE	A	DNS	L	L1	L2		
1HME05S03M02	SINGLE-PHASE	Y	0,37	80	127	Rp 1	414	-	-	10	10
1HME08S05M02		Z	0,55	80	171	Rp 1	467	168	99	10	12
1HME11S07M02			0,75	80	231	Rp 1	527	228	99	10	13
1HME15S11M02			1,1	80	311	Rp 1	607	308	99	16	15
1HME17S15M02		1,5	80	351	Rp 1	647	348	99	16	16	
3HME03S03M02		SINGLE-PHASE	Y	0,37	80	87	Rp 1	374	-	-	10
3HME05S05M02	Z		0,55	80	127	Rp 1	414	-	-	10	10
3HME07S07M02			0,75	80	151	Rp 1	447	148	99	10	11
3HME09S11M02			1,1	80	191	Rp 1	487	188	99	16	14
3HME12S15M02	1,5		80	251	Rp 1	547	248	99	16	15	
5HME02S03M02	SINGLE-PHASE		Y	0,37	80	104	Rp 1 1/4	391	-	-	10
5HME03S05M02		0,55		80	104	Rp 1 1/4	391	-	-	10	9
5HME04S07M02		0,75		80	129	Rp 1 1/4	416	-	-	10	10
5HME06S11M02		Z	1,1	80	158	Rp 1 1/4	454	153	99	10	12
5HME08S15M02			1,5	80	208	Rp 1 1/4	504	203	99	10	14

1-5hmes-esm-2p50-en\_a\_td

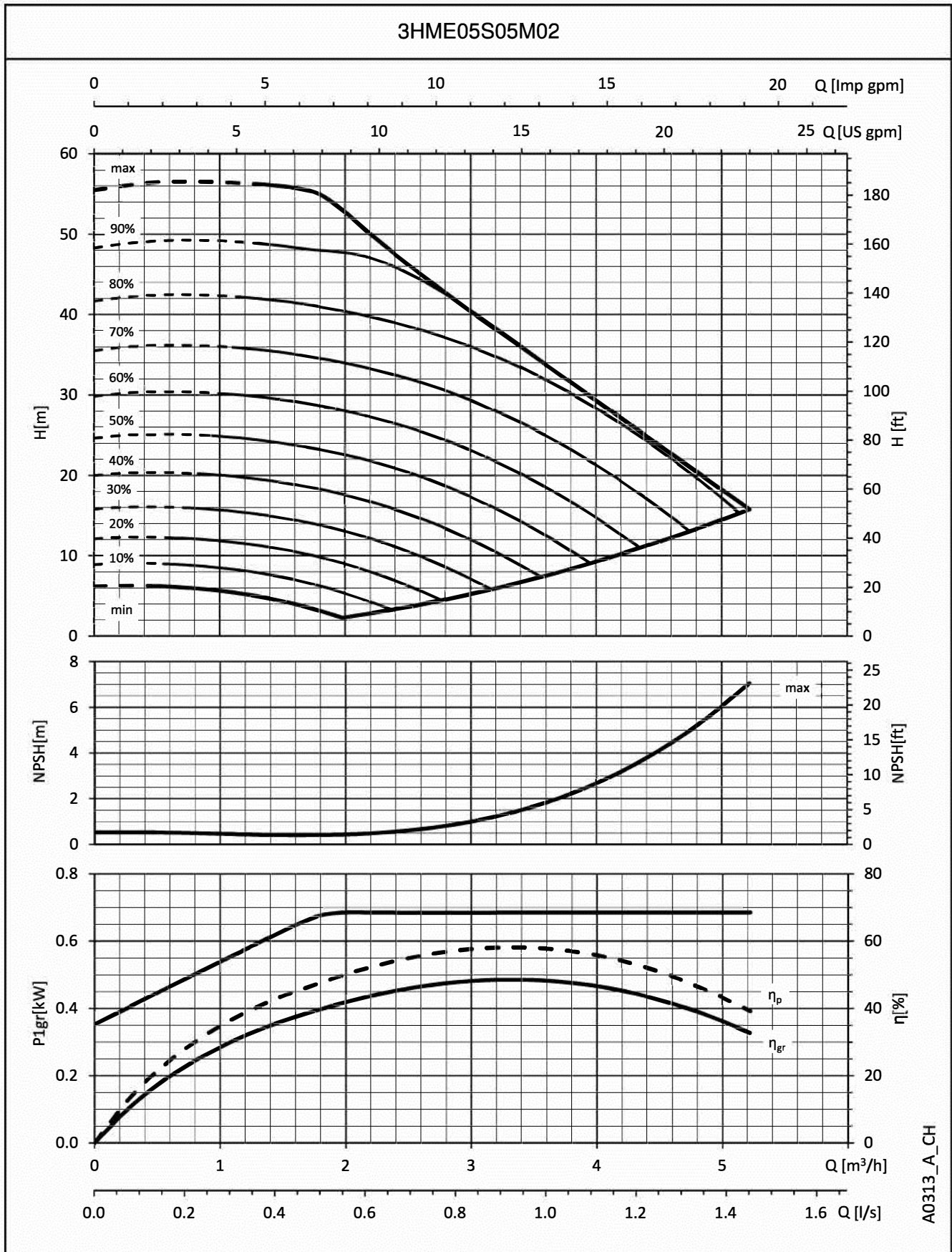
**3HME..S SERIES  
OPERATING CHARACTERISTICS**

A0313\_A\_CH

 The performances are valid for liquid with density  $\rho = 1 \text{ Kg/dm}^3$  and kinematic viscosity  $\nu = 1 \text{ mm}^2/\text{sec}$ .

### 3HME..S SERIES OPERATING CHARACTERISTICS

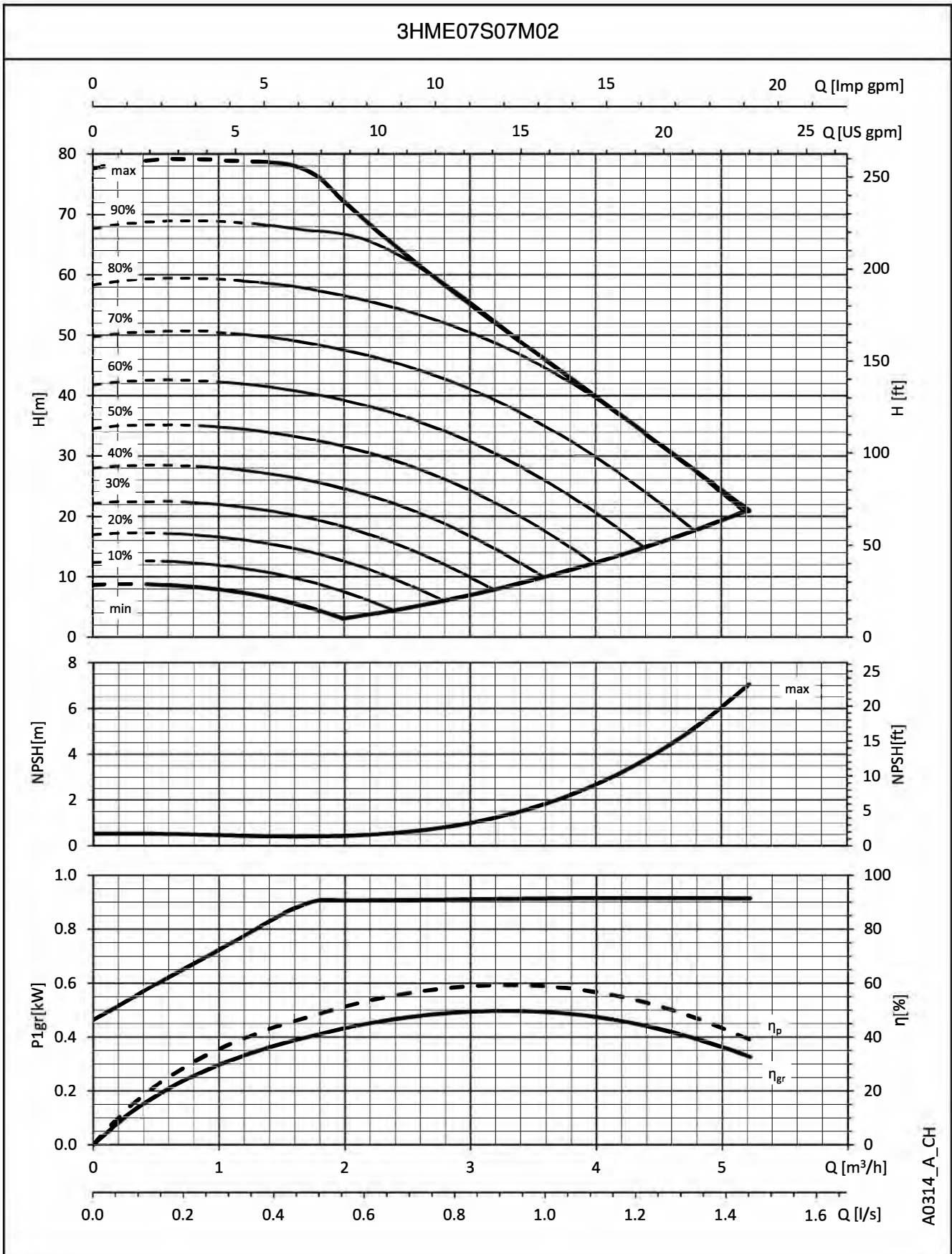

A0314\_A\_CH

The performances are valid for liquid with density  $\rho = 1 \text{ Kg/dm}^3$  and kinematic viscosity  $\nu = 1 \text{ mm}^2/\text{sec}$ .

### 3HME...S SERIES OPERATING CHARACTERISTICS

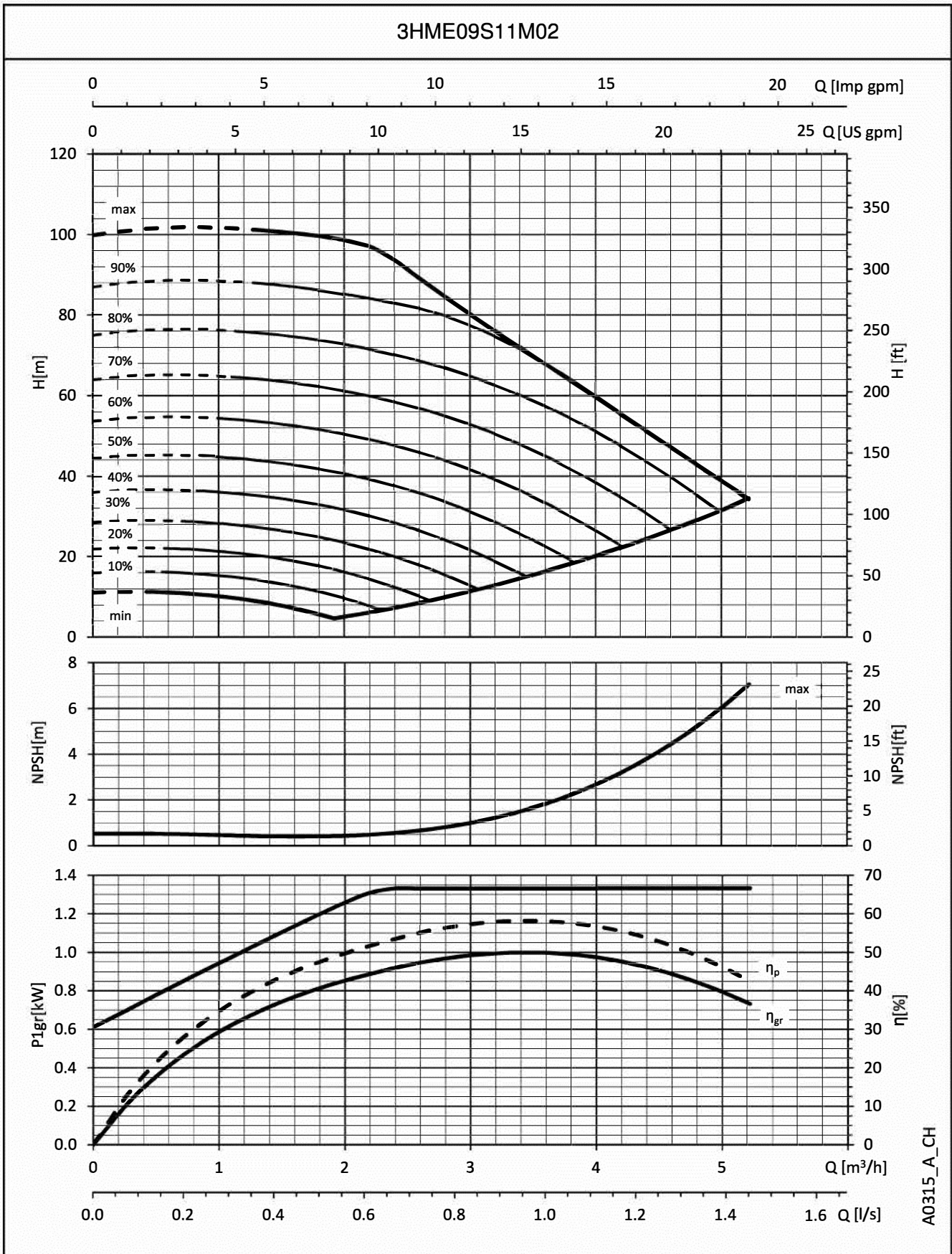

A0315\_A\_CH

The performances are valid for liquid with density  $\rho = 1 \text{ Kg/dm}^3$  and kinematic viscosity  $\nu = 1 \text{ mm}^2/\text{sec}$ .

### 5HME..S SERIES OPERATING CHARACTERISTICS

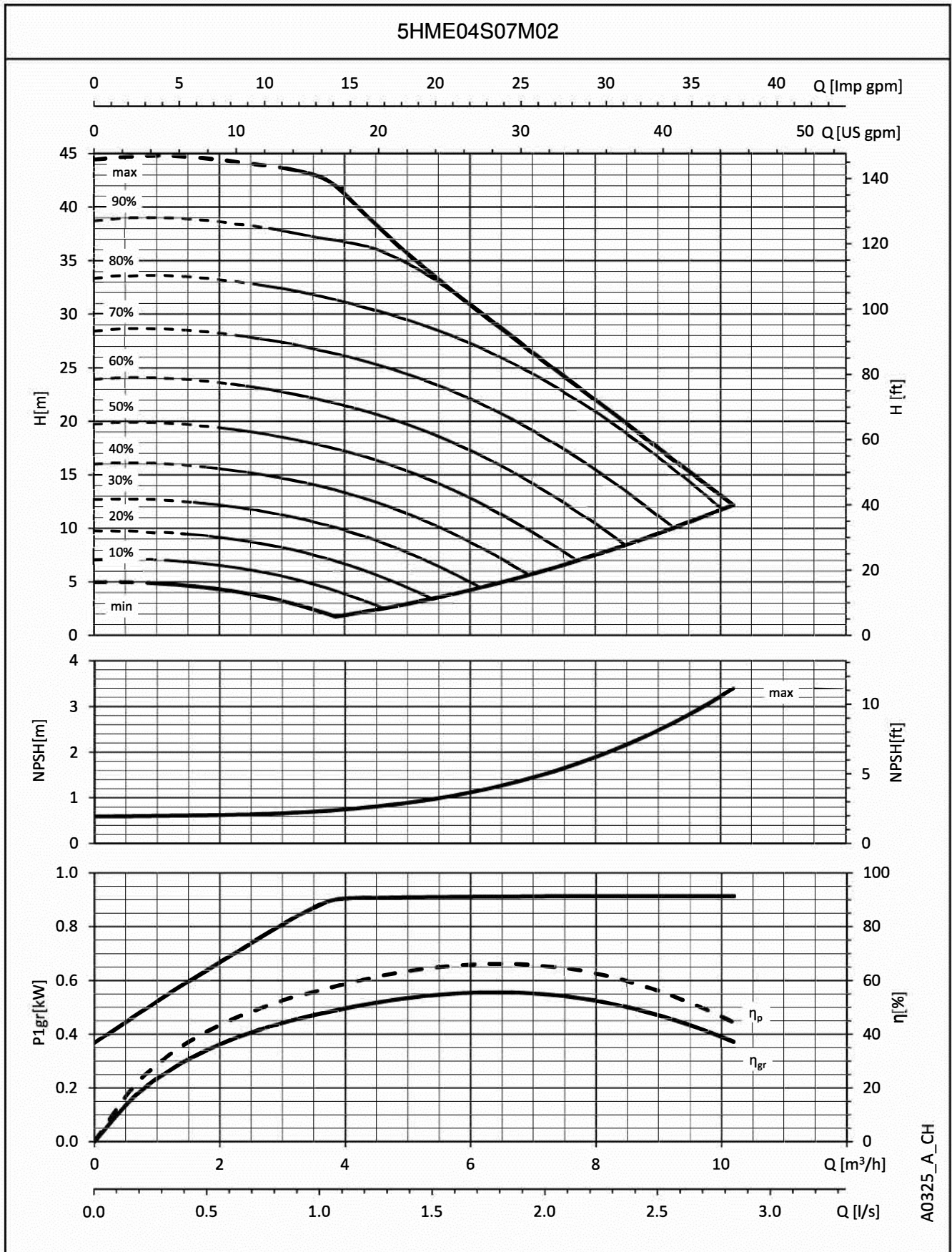

A0325\_A\_CH

The performances are valid for liquid with density  $\rho = 1 \text{ Kg/dm}^3$  and kinematic viscosity  $\nu = 1 \text{ mm}^2/\text{sec}$ .

### 5HME..S SERIES OPERATING CHARACTERISTICS

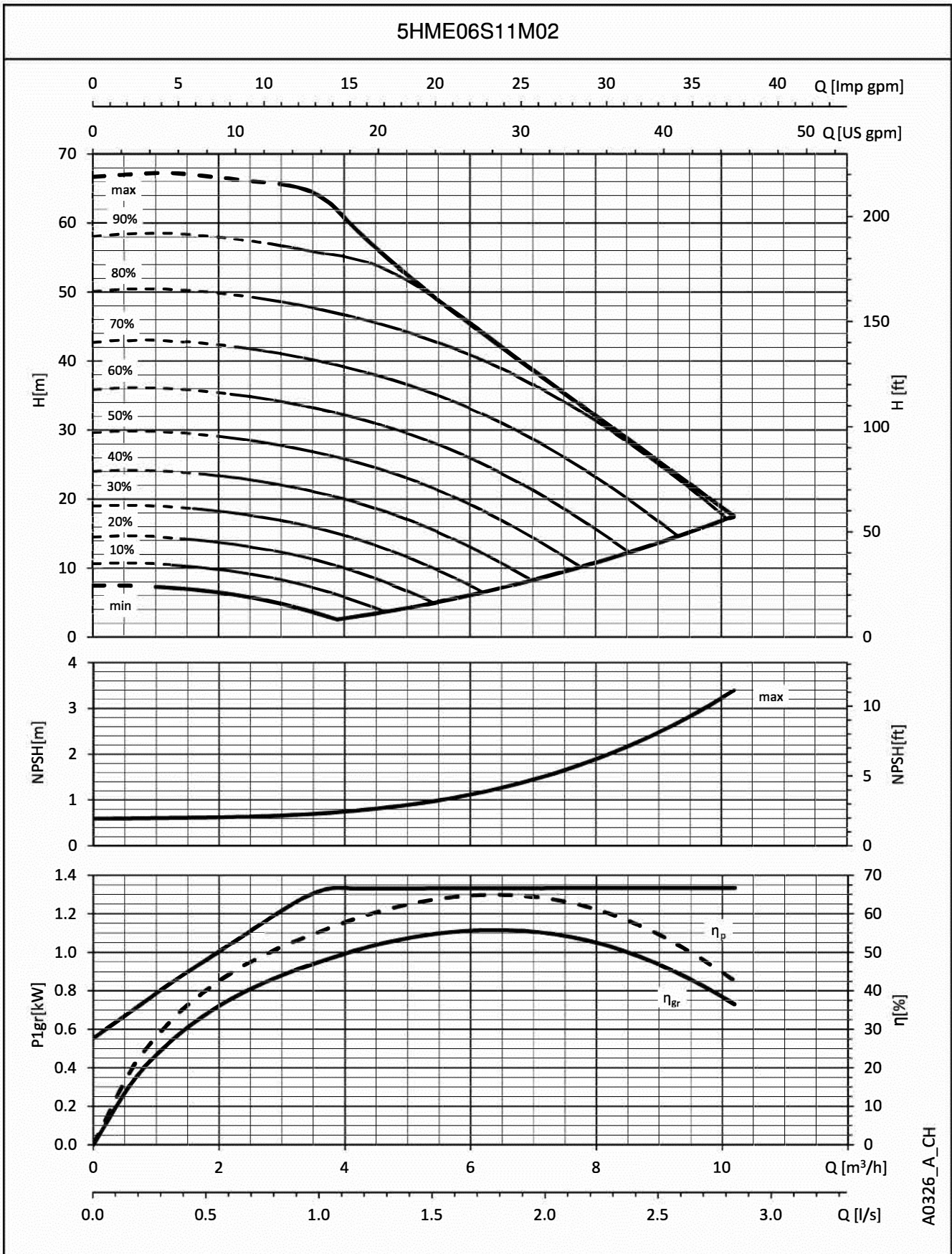

A0326\_A\_CH

The performances are valid for liquid with density  $\rho = 1 \text{ Kg/dm}^3$  and kinematic viscosity  $\nu = 1 \text{ mm}^2/\text{sec}$ .

### 5HME..S SERIES OPERATING CHARACTERISTICS

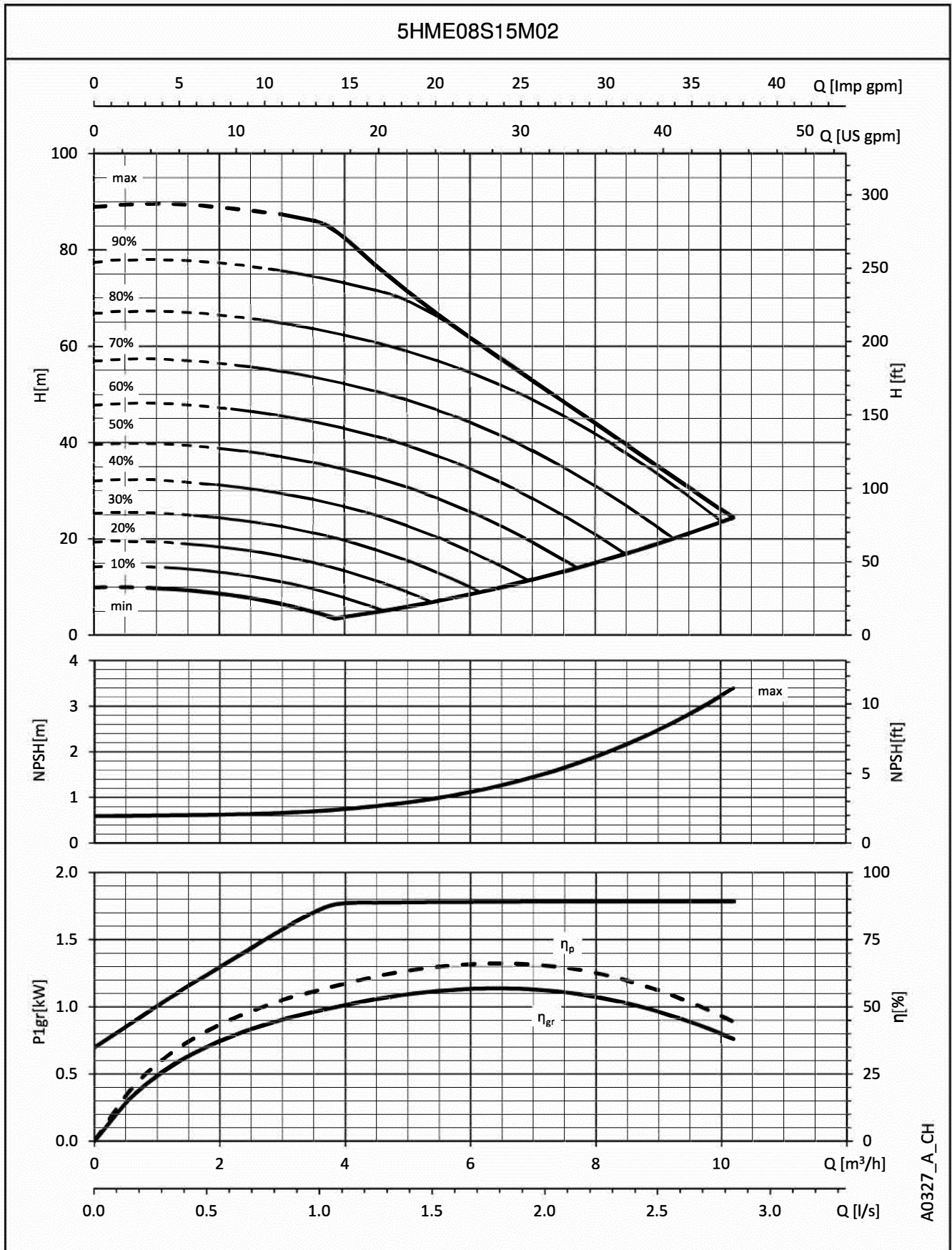

A0327\_A\_CH

The performances are valid for liquid with density  $\rho = 1 \text{ Kg/dm}^3$  and kinematic viscosity  $\nu = 1 \text{ mm}^2/\text{sec}$ .



**10HME..S SERIES  
OPERATING CHARACTERISTICS**

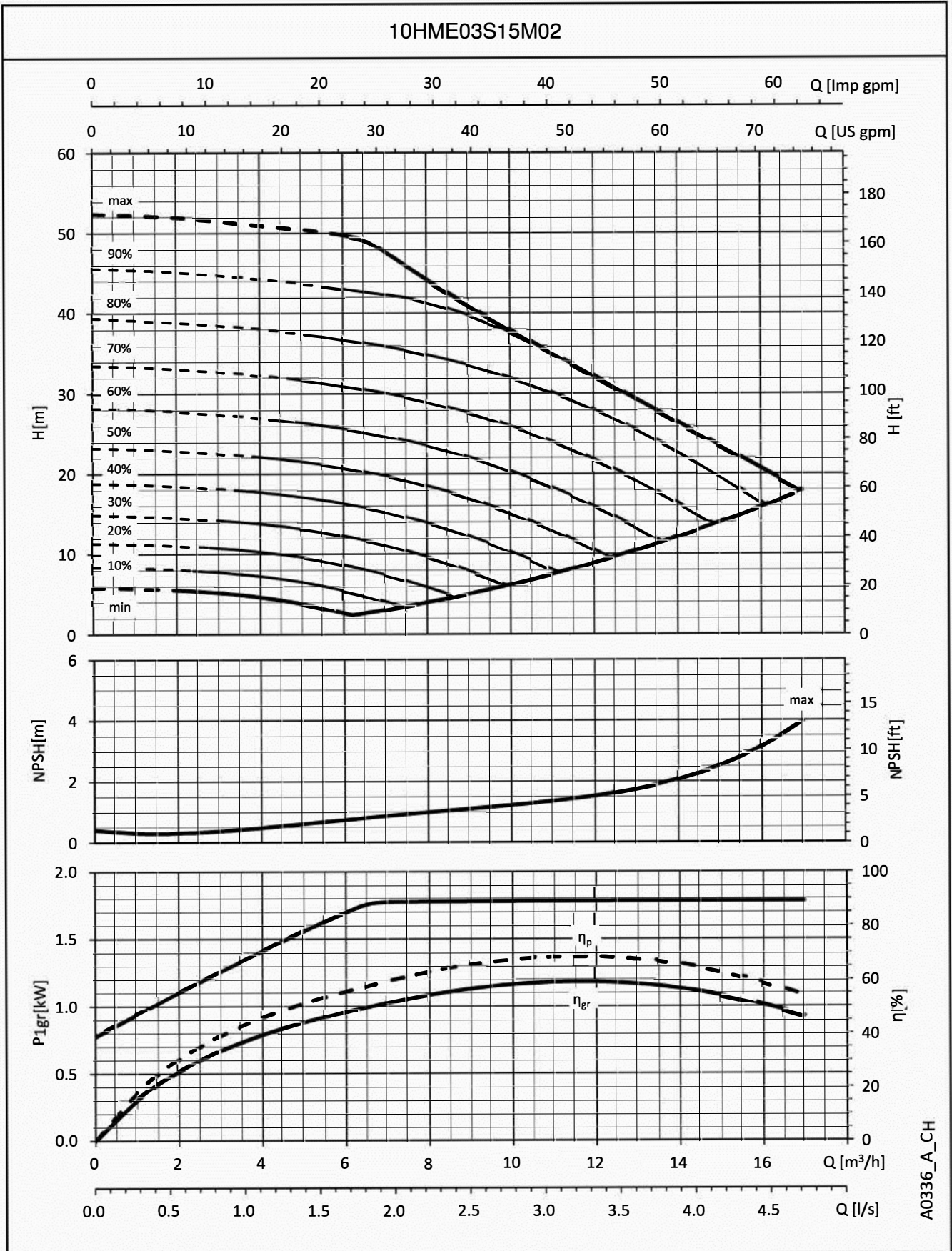

The performances are valid for liquid with density  $\rho = 1 \text{ Kg/dm}^3$  and kinematic viscosity  $\nu = 1 \text{ mm}^2/\text{sec}$ .





# Smart Pump Range

Permanent magnet motors with embedded drive and high-efficiency hydraulics.

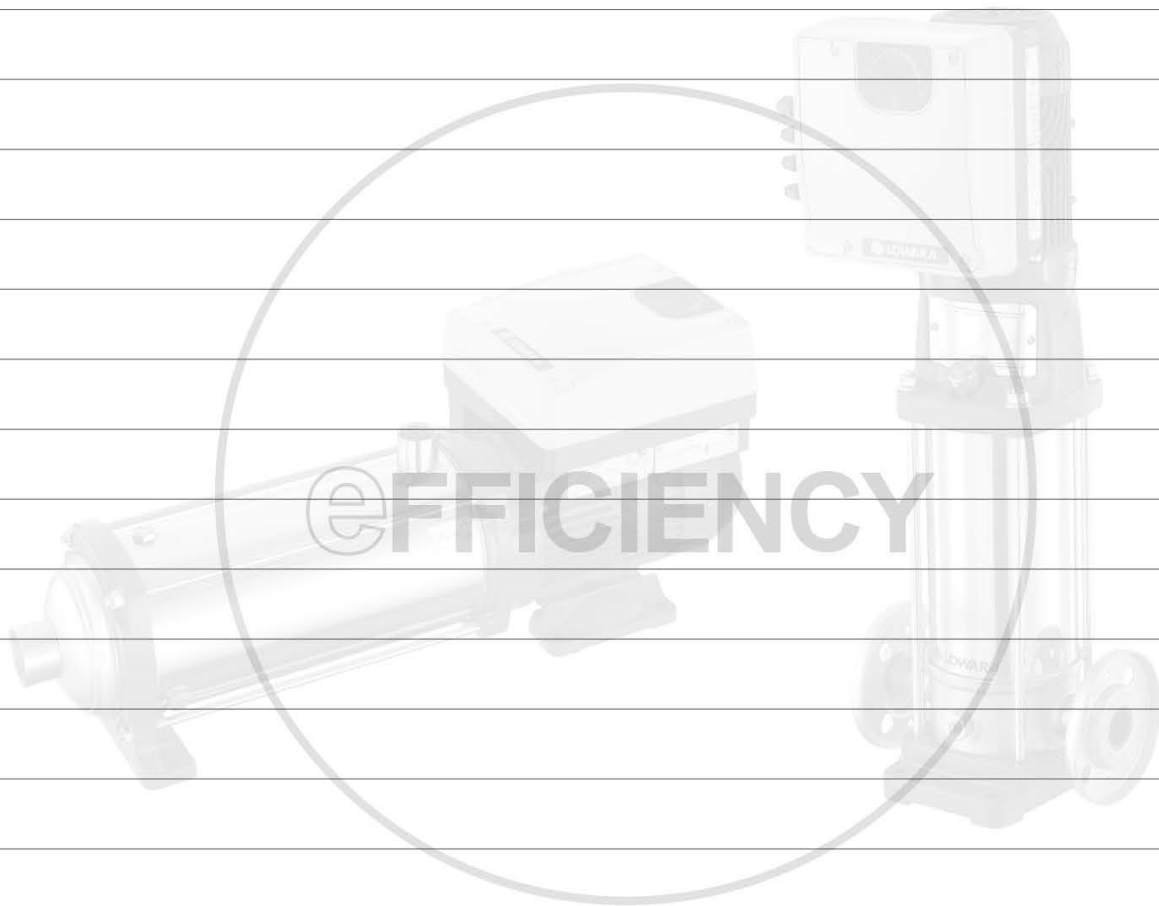

Contact your nearest branch for more information on the Smart Pump range.



Melbourne Sydney Brisbane  
1300 4 BBENG | [www.brownbros.com.au](http://www.brownbros.com.au)

DELIVERING PUMPING SOLUTIONS

# **e-SVE**

## **Version with drive and permanent magnet motor (e-SM Drive)**



## e-SVE SERIES e-SV SMART SERIES

### Background and context

In every sector, from construction and industry to agriculture and building services the need for intelligent, compact and high-efficiency pumping systems is constantly growing.

That's why Lowara has developed the e-SV Smart series: an integrated intelligent pumping system with electronically driven, permanent magnet motor (IE5 efficiency level).

The integrated control system, combined with the high performance, power and efficiency from the motor and hydraulics, guarantees impressively low operating costs. You also benefit from flexibility, precision and its ultra-compact size.

### Savings

The electronics and permanent magnet motor are highly efficient and minimize power losses while transferring maximum energy to the hydraulic parts of the pump.

The refined control system with integrated microprocessor adjusts the motor speed, matching the required operating point of the pump or system requirements.

This reduces demand on electricity according to the required working conditions.

This creates economies, especially in systems where pump demand varies over time.

### Flexibility

The compact size, low loss and increased control make the e-SV Smart series a good choice in applications and systems where fixed speed pumps are commonly used. The e-SV Smart series is easy to integrate in control and regulation loops thanks to the wide availability of compatible communication protocols, including analog and digital inputs.

The pump is supplied with a pressure sensor.

### Ease of use and commissioning

e-SV Smart has an intuitive interface that guides the user through the installation, and a practical area to assist with connections.

The control system is integrated and no additional external electrical panel is required

### Application sectors

- Water supply systems in residential buildings
- Air conditioning
- Water treatment plants
- Industrial installations



### Identification code

The electrical voltage supply of e-SVE models is identified by the last characters.

Example: 22SVE02F015P0**M/2**

**M/2** = 1x208-240 V

**T/4** = 3x380-460 V

**T/5** = 3x208-240/380-460 V

### e-SM system

- 230V +/- 10% single phase power supply, 50/60 Hz
- Power up to 1,5 kW
- Protection class IP55
- Can be linked up to 3 e-SV Smart pumps

### Pump

- Flow rate: up to 30 m<sup>3</sup>/h
- Head: up to 180 m
- Environment temperature: -20° C to +50° C with no performance derating
- Temperature of pumped liquid: up to +120°C for single-phase motor versions
- Maximum operating pressure 25 bar (PN 25)
- The hydraulic performances meet the tolerances specified in ISO 9906:2012.

### Motor

- IE5 efficiency level (IEC TS 60034-30-3:2016)
- Synchronous electric motor with permanent magnets, (TEFC), closed structure, air-cooled
- Insulation class 155 (F)
- Overload protection and locked rotor with automatic reset incorporated

**e-SVE SERIES**  
**e-SV SMART SERIES**

e-SV Smart series is equipped with an intelligent control that optimizes hydraulic performance while minimizing waste.

**Integrated intelligence:** The electronic control of the motor enables a 20% increase in performance compared to an equivalent fixed speed pump (area highlighted in figure "Integrated intelligence").

**Adjustment:** This is possible both at constant pressure and according to the characteristic curve of the system, based on the customer's preferences. Another option is according to an external signal or at a preset speed.

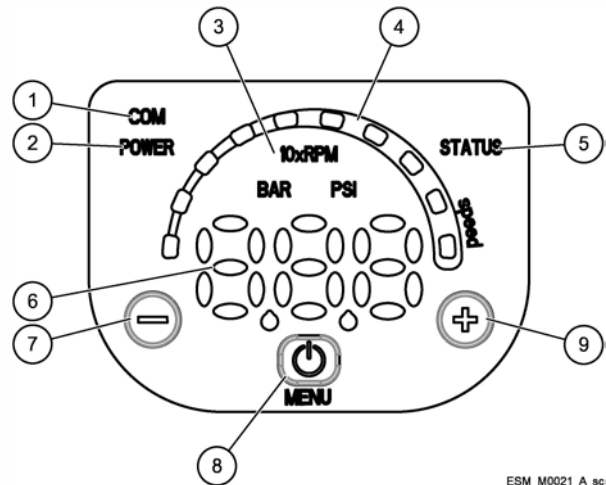

ESM\_M0021\_A\_sc

**Intuitive and simple interface:** You can control the unit from just three buttons, with an easy to read display for parameters and alarms, designed for complete control of system operation.

- ① Communication LED
- ② Power on LED
- ③ Unit of measure LED
- ④ Speed LED bar
- ⑤ Status LED
- ⑥ Numeric display
- ⑦ ⊖ Decrease key
- ⑧ ⏻ On/off and menu key
- ⑨ ⊕ Increase key

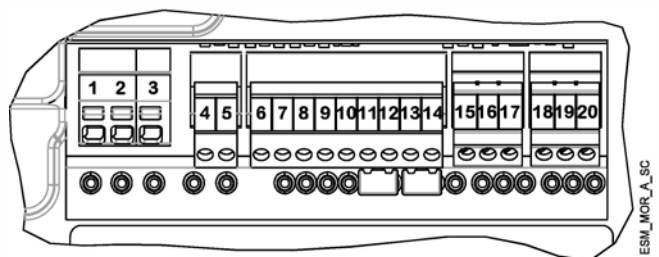

ESM\_M0CR\_A\_SC

**Terminal block**

- e-SV Smart has the following terminals::
- 1, 2, 3 = Power supply (⊕, L, N)
  - 4, 5 = Fault signal (NO) - (Ext  $V_{max} < 250 \text{ VAC}$  -  $I_{max} < 2\text{A}$ )
  - 6 = Auxiliary voltage supply +15 VDC
  - 7, 8 = Analog 0-10V
  - 9 = Power supply external sensor +15 VDC
  - 10 = External sensor 4-20 mA input
  - 11, 12 = External start/stop
  - 13, 14 = External lack of water
  - 15, 16, 17 = Communication bus RS485, protocol Modbus and BACnet
  - 18, 19, 20 = Communication bus RS485, enabled via dedicated module

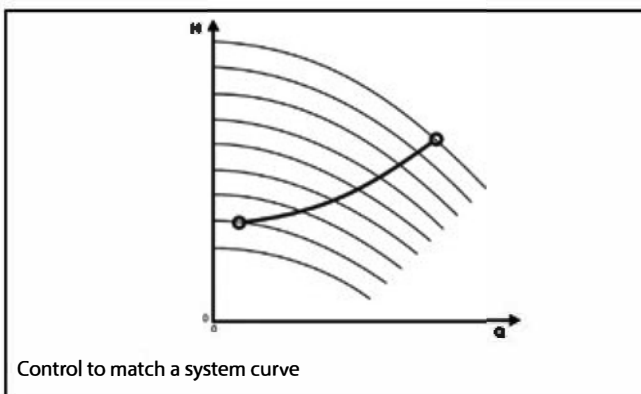
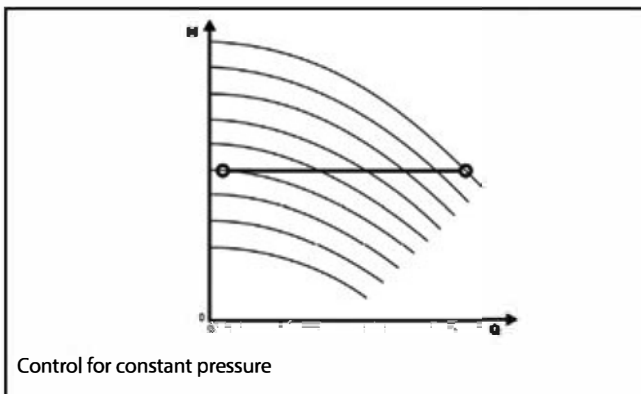
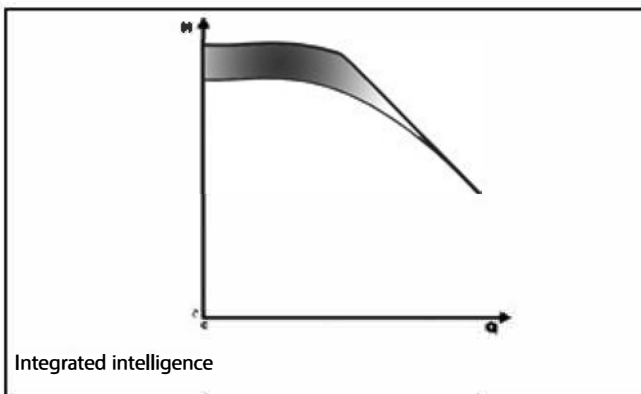

## e-SVE SERIES HOW TO READ SMART PUMP SERIES CURVES

To exploit to the maximum potential of Smart Pumps it's important to properly read working curves:

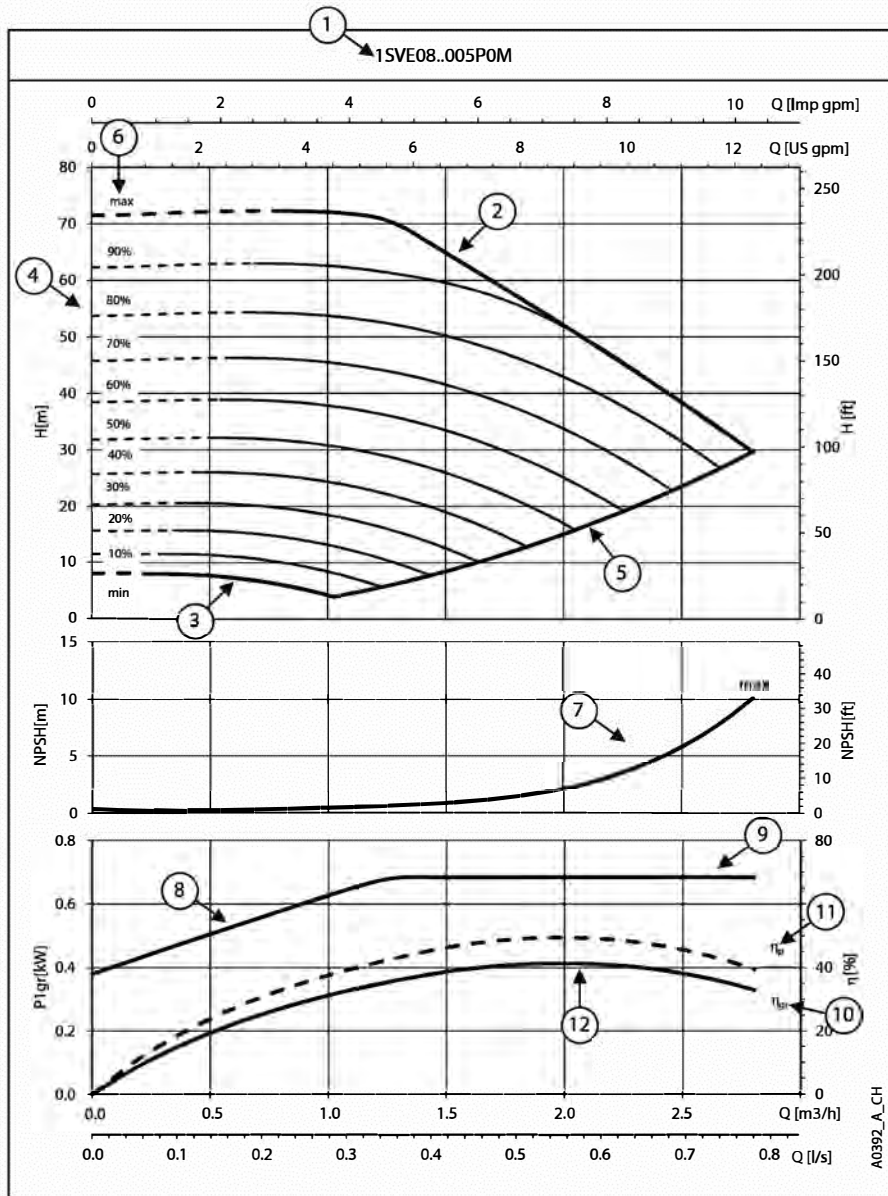

① **Pump model**

② **Maximum speed curve:** equal to 3600 rpm

③ **Minimum speed curve:** it refers to the minimum rpm level the motor can work at, it's calculated depending on the model of pump maximizing for each one the working area and allowing the highest system flexibility.

④ The **area with dotted lines** is where the pump can only operate intermittently for short periods of time.

⑤ Each **intermediate curve** between max and min speed shows the percentage of load the pump+motor+drive system is working at; it's easy to read also from the LED speed bar on the HMI keypad: at 90% there will be 9 led, at 80% there will be 8 and so on.

Example: at 60% there will be 6 led's

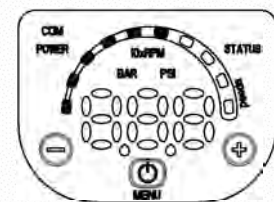

⑥ The **part load percentage** is calculated depending on maximum speed (*max*, 100%) and minimum speed (*min*, equal to 0%, which is the minimum part load step, below it the drive stays powered up but cannot work).

⑦ **NPSH**: is the net positive suction head of pump+motor+drive system working at maximum speed.

⑧ **P1<sub>gr</sub>** is the power absorption in kW of pump+motor+drive system working at maximum speed.

⑨ **Load control**: the Smart Pump controls and limits power consumption at high flow/low head, in this way the motor stays protected from overload and ensure a longer life of pump+motor+drive system.

⑩  $\eta_{gr}$  is the efficiency of pump+motor+drive system working at maximum speed.

⑪  $\eta_p$  is the efficiency of the hydraulic part, working at maximum speed.

⑫ **Working point**: it's important to make sure the pump is working at the best working point, the one at highest efficiency.

It's easy to find it: it's the highest point of the  $\eta_p$  pump efficiency curve; once you found it, you can learn also flow values from x-axis called Q and head values from y-axis called H which allow the system to work at the best working point.

## e-SVE SERIES

### HYDRAULIC PERFORMANCES TABLE

POMPA TIPO SVE Monofase	MOTORE		GRUPPO e-SM		Q = PORTATA							
	P <sub>N</sub> kW	TIPO 1x230 V	* P <sub>1</sub> kW	* I 208-240 V A	l/min 0	6,7	13,3	20,0	26,7	33,3	40,0	46,7
					m <sup>3</sup> /h 0	0,4	0,8	1,2	1,6	2,0	2,4	2,8
H = PREVALENZA TOTALE IN METRI COLONNA ACQUA												
1SVE05..003POM	0,37	ESM90R/103 SVE	0,49	2,24	44,7	45,0	45,2	44,6	41,5	35,0	28,1	20,8
1SVE08..005POM	0,55	ESM90R/105 SVE	0,68	3,07	71,5	72,0	72,3	71,2	62,3	52,0	41,2	29,6
1SVE11..007POM	0,75	ESM90R/107 SVE	0,91	4,04	98,3	99,1	99,3	97,7	85,1	70,9	56,0	40,0
1SVE15..011POM	1,1	ESM90R/111 SVE	1,33	5,85	134,1	135,1	135,5	133,8	123,6	103,9	83,3	61,4
1SVE20..015POM	1,5	ESM90R/115 SVE	1,78	7,79	178,9	180,1	180,6	178,5	168,0	141,6	114,0	84,7

POMPA TIPO SVE Monofase	MOTORE		GRUPPO e-SM		Q = PORTATA							
	P <sub>N</sub> kW	TIPO 1x230 V	* P <sub>1</sub> kW	* I 208-240 V A	l/min 0	13,3	26,7	40,0	53,3	66,7	80,0	86,7
					m <sup>3</sup> /h 0	0,8	1,6	2,4	3,2	4,0	4,8	5,2
H = PREVALENZA TOTALE IN METRI COLONNA ACQUA												
3SVE03..003POM	0,37	ESM90R/103 SVE	0,49	2,24	33,4	33,7	33,6	30,7	24,9	19,5	14,0	10,9
3SVE05..005POM	0,55	ESM90R/105 SVE	0,69	3,08	55,7	56,2	55,8	46,3	37,1	28,4	19,5	14,4
3SVE07..007POM	0,75	ESM90R/107 SVE	0,92	4,06	77,9	78,7	77,2	63,4	50,7	38,6	26,0	18,7
3SVE09..011POM	1,1	ESM90R/111 SVE	1,33	5,85	100,2	101,0	100,5	88,8	72,5	56,4	39,9	31,2
3SVE11..015POM	1,5	ESM90R/115 SVE	1,78	7,80	122,5	123,3	122,5	117,9	98,4	78,0	57,2	46,3

POMPA TIPO SVE Monofase	MOTORE		GRUPPO e-SM		Q = PORTATA							
	P <sub>N</sub> kW	TIPO 1x230 V	* P <sub>1</sub> kW	* I 208-240 V A	l/min 0	23,3	46,7	70,0	93,3	116,7	140,0	166,7
					m <sup>3</sup> /h 0	1,4	2,8	4,2	5,6	7,0	8,4	10,0
H = PREVALENZA TOTALE IN METRI COLONNA ACQUA												
5SVE02..003POM	0,37	ESM90R/103 SVE	0,49	2,24	22,4	22,2	21,8	20,0	16,5	13,3	10,2	6,5
5SVE03..005POM	0,55	ESM90R/105 SVE	0,68	3,07	33,5	33,3	32,7	29,8	24,5	19,8	15,2	9,5
5SVE04..007POM	0,75	ESM90R/107 SVE	0,91	4,05	44,7	44,4	43,5	40,5	33,4	27,1	20,8	13,3
5SVE06..011POM	1,1	ESM90R/111 SVE	1,33	5,86	67,1	66,6	65,3	59,5	49,0	39,6	30,4	19,1
5SVE08..015POM	1,5	ESM90R/115 SVE	1,78	7,81	88,8	89,3	87,6	82,6	68,3	55,3	42,6	27,9

POMPA TIPO SVE Monofase	MOTORE		GRUPPO e-SM		Q = PORTATA							
	P <sub>N</sub> kW	TIPO 1x230 V	* P <sub>1</sub> kW	* I 208-240 V A	l/min 0	40,0	80,0	120,0	160,0	200,0	240,0	283,3
					m <sup>3</sup> /h 0	2,4	4,8	7,2	9,6	12,0	14,4	17,0
H = PREVALENZA TOTALE IN METRI COLONNA ACQUA												
10SVE01..005POM	0,55	ESM90R/105 SVE	0,68	3,07	17,3	17,3	16,9	16,2	13,6	10,4	7,1	3,3
10SVE02..007POM	0,75	ESM90R/107 SVE	0,92	4,09	24,2	23,9	23,1	21,7	19,3	14,6	9,7	3,6
10SVE02..011POM	1,1	ESM90R/111 SVE	1,33	5,85	34,8	34,5	33,7	32,3	27,7	22,4	17,1	11,0
10SVE03..015POM	1,5	ESM90R/115 SVE	1,78	7,81	52,7	52,2	51,0	46,1	38,1	30,8	23,5	15,1

POMPA TIPO SVE Monofase	MOTORE		GRUPPO e-SM		Q = PORTATA							
	P <sub>N</sub> kW	TIPO 1x230 V	* P <sub>1</sub> kW	* I 208-240 V A	l/min 0	70,0	140,0	210,0	280,0	350,0	420,0	483,3
					m <sup>3</sup> /h 0	4,2	8,4	12,6	16,8	21,0	25,2	29,0
H = PREVALENZA TOTALE IN METRI COLONNA ACQUA												
15SVE01..007POM	0,75	ESM90R/107 SVE	0,92	4,10	14,2	13,9	13,3	12,3	9,8	6,4	2,8	
15SVE01..011POM	1,1	ESM90R/111 SVE	1,33	5,85	20,5	20,1	19,4	18,4	14,8	10,9	7,0	3,2
15SVE02..015POM	1,5	ESM90R/115 SVE	1,76	7,71	29,6	29,1	28,3	26,8	22,2	16,4	10,1	3,8

POMPA TIPO SVE Monofase	MOTORE		GRUPPO e-SM		Q = PORTATA							
	P <sub>N</sub> kW	TIPO 1x230 V	* P <sub>1</sub> kW	* I 208-240 V A	l/min 0	70,0	140,0	210,0	280,0	350,0	420,0	500,0
					m <sup>3</sup> /h 0	4,2	8,4	12,6	16,8	21,0	25,2	30,0
H = PREVALENZA TOTALE IN METRI COLONNA ACQUA												
22SVE01..007POM	0,75	ESM90R/107 SVE	0,89	3,95	14,4	14,4	14,1	12,5	9,5	6,3	2,9	
22SVE01..011POM	1,1	ESM90R/111 SVE	1,34	5,87	20,7	20,8	20,5	18,7	15,1	11,5	7,8	3,2
22SVE02..015POM	1,5	ESM90R/115 SVE	1,72	7,56	31,4	31,0	30,3	26,7	21,7	16,7	11,0	2,8

\* Valori massimi nel campo di funzionamento: P<sub>1</sub> = potenza assorbita; I = corrente assorbita.

1-22sve-esm-2p50\_a\_th

## e-SVE SERIES ELECTRICAL DATA TABLE

In the range 3000-3600 rpm the nominal motor power is guaranteed. Above 3600 rpm it isn't possible work and the motor is automatically limited; below 3000 rpm it works partially load.

P <sub>N</sub> kW	MOTOR TYPE	IEC SIZE*	Construction Design	SPEED (RPM)** min <sup>-1</sup>	INPUT CURRENT I (A) 208-240 V	DATA RELATED TO THE VOLTAGE OF 230V					IES	
						I <sub>n</sub> A	cosφ	T <sub>n</sub> Nm	η %			
									4/4	3/4		2/4
0,37	ESM90R/103 SVE	90R	V18/B14	3000	2,28-1,99	2,08	0,95	1,18	81,3	79,1	74,3	2
				3600	2,30-2,02	2,10		0,98	80,6	77,5	72,0	
0,55	ESM90R/105 SVE	90R		3000	3,27-2,85	2,96	0,97	1,75	83,3	82,2	78,8	2
				3600	3,27-2,85	2,96		1,46	83,3	81,5	77,5	
0,75	ESM90R/107 SVE	90R		3000	4,43-3,84	4,00	0,98	2,39	83,3	83,3	81,5	2
				3600	4,38-3,79	3,94		1,99	84,5	83,5	80,6	
1,10	ESM90R/111 SVE	90R		3000	6,26-5,35	5,64	0,99	3,50	85,7	85,1	82,7	2
				3600	6,20-5,32	5,63		2,92	85,9	84,6	81,4	
1,50	ESM90R/115 SVE	90R		3000	8,57-7,32	7,69	0,99	4,77	85,6	85,7	84,7	2
				3600	8,42-7,25	7,62		3,98	86,3	85,9	84,0	

\* R = Reduced size of motor casing as compared to shaft extension and flange.

eSV\_Smart-motm\_en\_a\_te

\*\* The indicated rotational speed are representing the upper and lower limits of the rated power operational speed range.

## 1, 3, 5SVE..F SERIES DIMENSIONS AND WEIGHTS

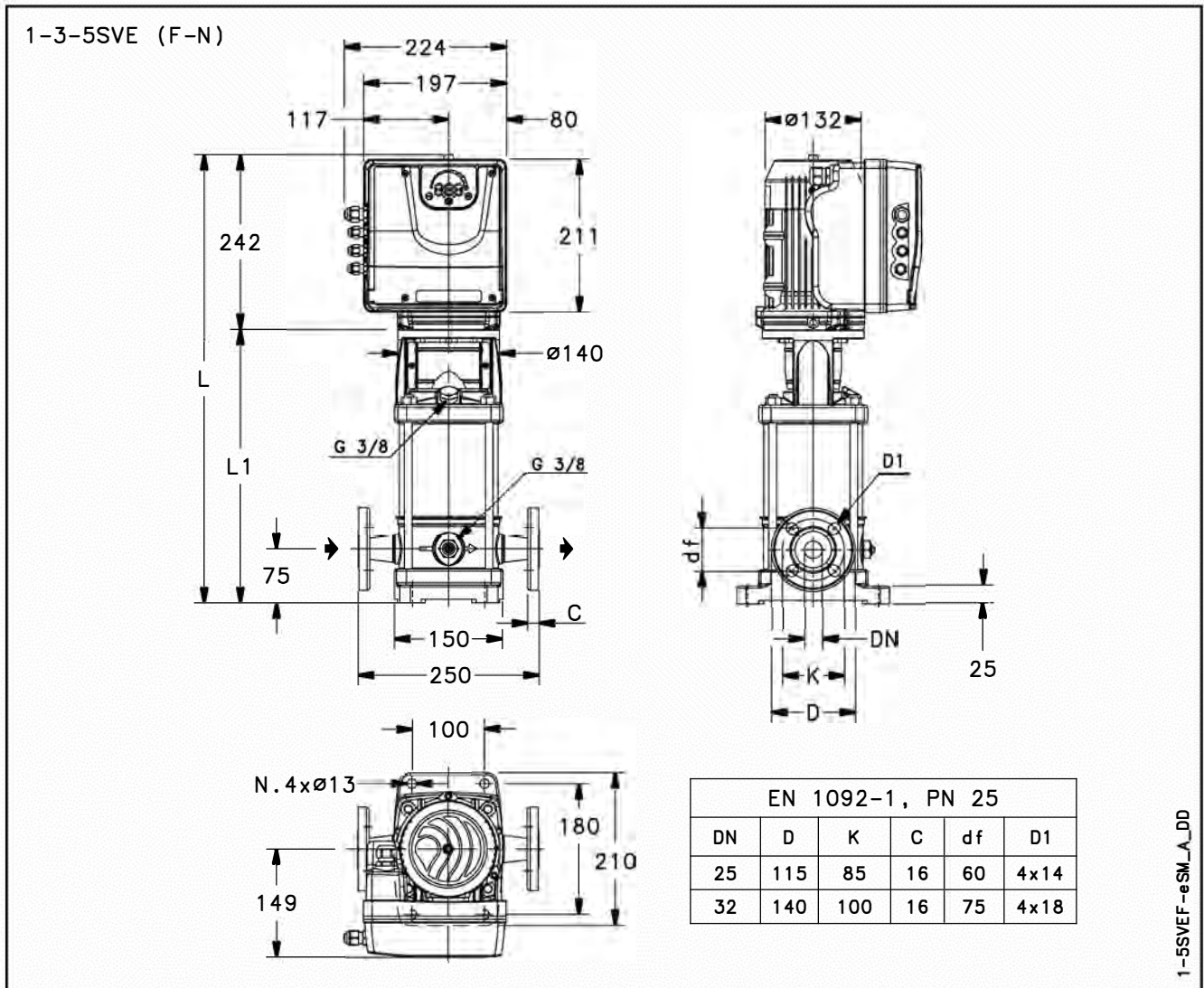

PUMP TYPE SVE F (SINGLE-PHASE)	MOTOR		DIMENSIONS (mm)			WEIGHT (kg)	
	kw	SIZE	L	L1	DN	PUMP	ELECTRIC PUMP
1SVE05F003P0M	0,37	90	580	338	25	10,1	17,6
1SVE08F005P0M	0,55	90	640	398	25	11,2	18,7
1SVE11F007P0M	0,75	90	700	458	25	12,4	19,9
1SVE15F011P0M	1,1	90	780	538	25	14,2	23,2
1SVE20F015P0M	1,5	90	880	638	25	16,2	25,2
3SVE03F003P0M	0,37	90	540	298	25	9,1	16,6
3SVE05F005P0M	0,55	90	580	338	25	9,9	17,4
3SVE07F007P0M	0,75	90	620	378	25	11,2	18,7
3SVE09F011P0M	1,1	90	660	418	25	12	21
3SVE11F015P0M	1,5	90	700	458	25	12,8	21,8
5SVE02F003P0M	0,37	90	530	288	32	9,1	16,6
5SVE03F005P0M	0,55	90	555	313	32	9,6	17,1
5SVE04F007P0M	0,75	90	580	338	32	10,1	17,6
5SVE06F011P0M	1,1	90	630	388	32	11,3	20,3
5SVE08F015P0M	1,5	90	680	438	32	12,4	21,4

1-5svef-esm-2p50-en\_a\_ttd

### 3SVE SERIES OPERATING CHARACTERISTICS

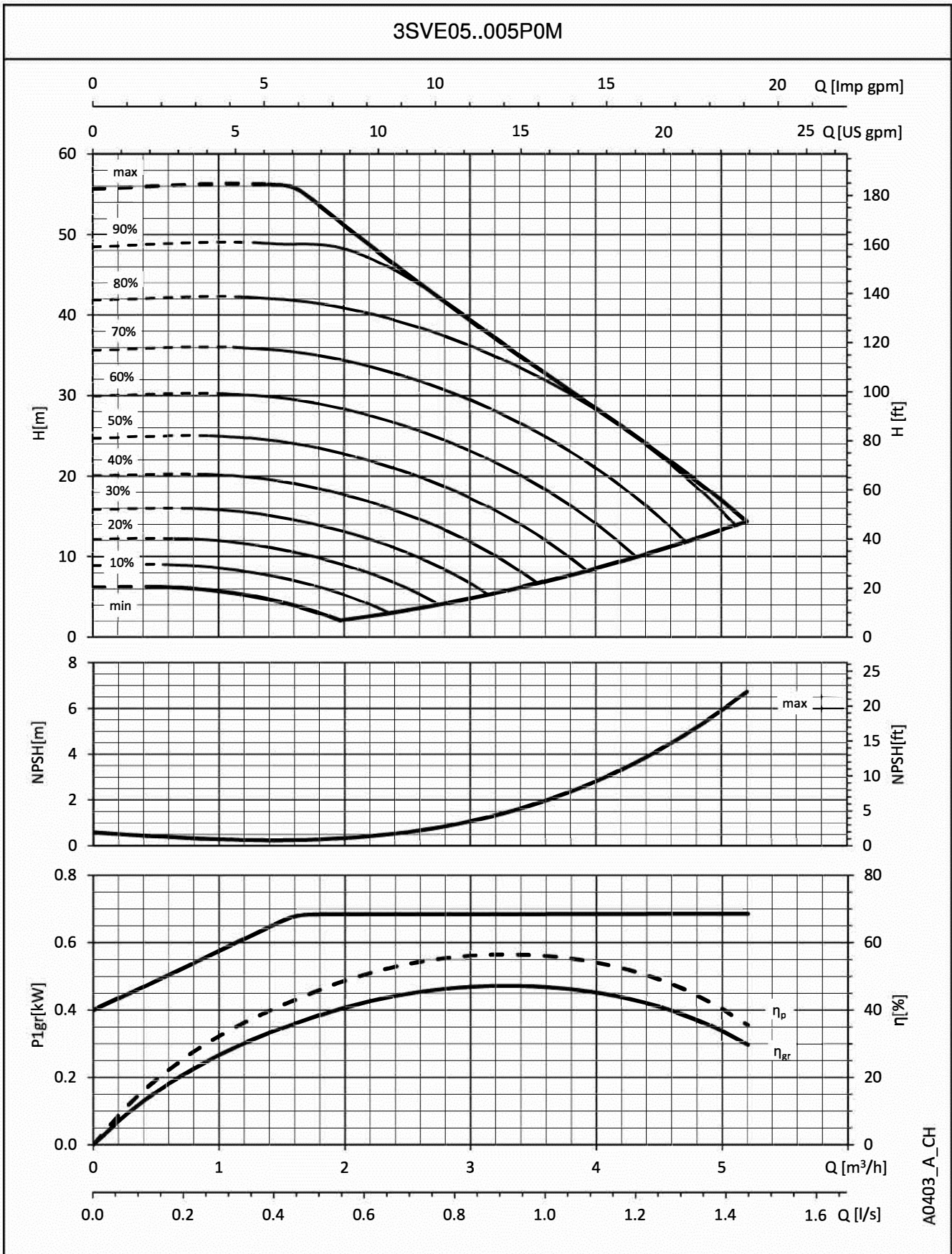

A0403\_A\_CH

The performances are valid for liquid with density  $\rho = 1.0 \text{ Kg/dm}^3$  and kinematic viscosity  $\nu = 1 \text{ mm}^2/\text{sec}$ .

### 3SVE SERIES OPERATING CHARACTERISTICS

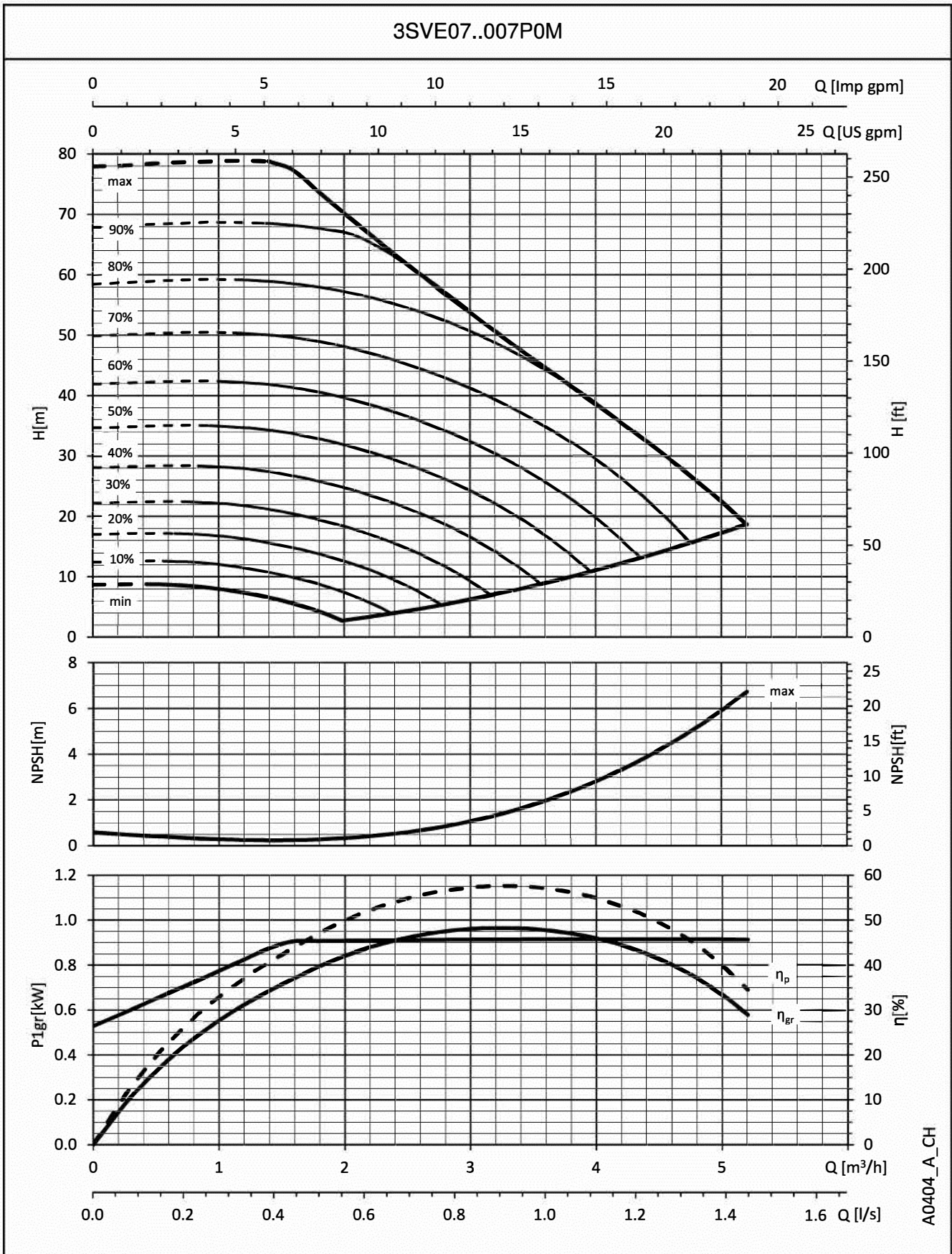

A0404\_A\_CH

The performances are valid for liquid with density  $\rho = 1.0 \text{ Kg/dm}^3$  and kinematic viscosity  $\nu = 1 \text{ mm}^2/\text{sec}$ .

### 3SVE SERIES OPERATING CHARACTERISTICS

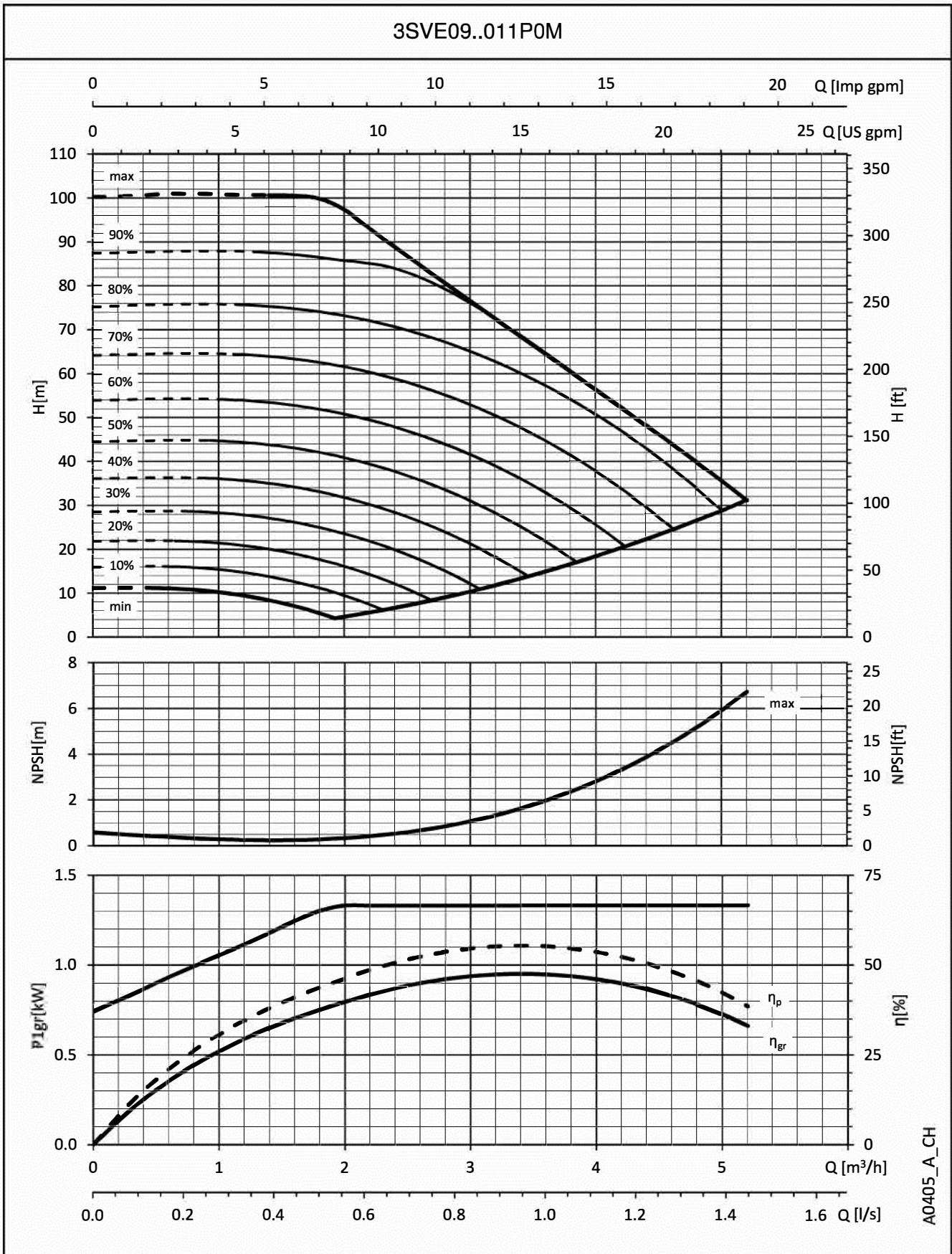

A0405\_A\_CH

The performances are valid for liquid with density  $\rho = 1.0 \text{ Kg/dm}^3$  and kinematic viscosity  $\nu = 1 \text{ mm}^2/\text{sec}$ .

### 3SVE SERIES OPERATING CHARACTERISTICS

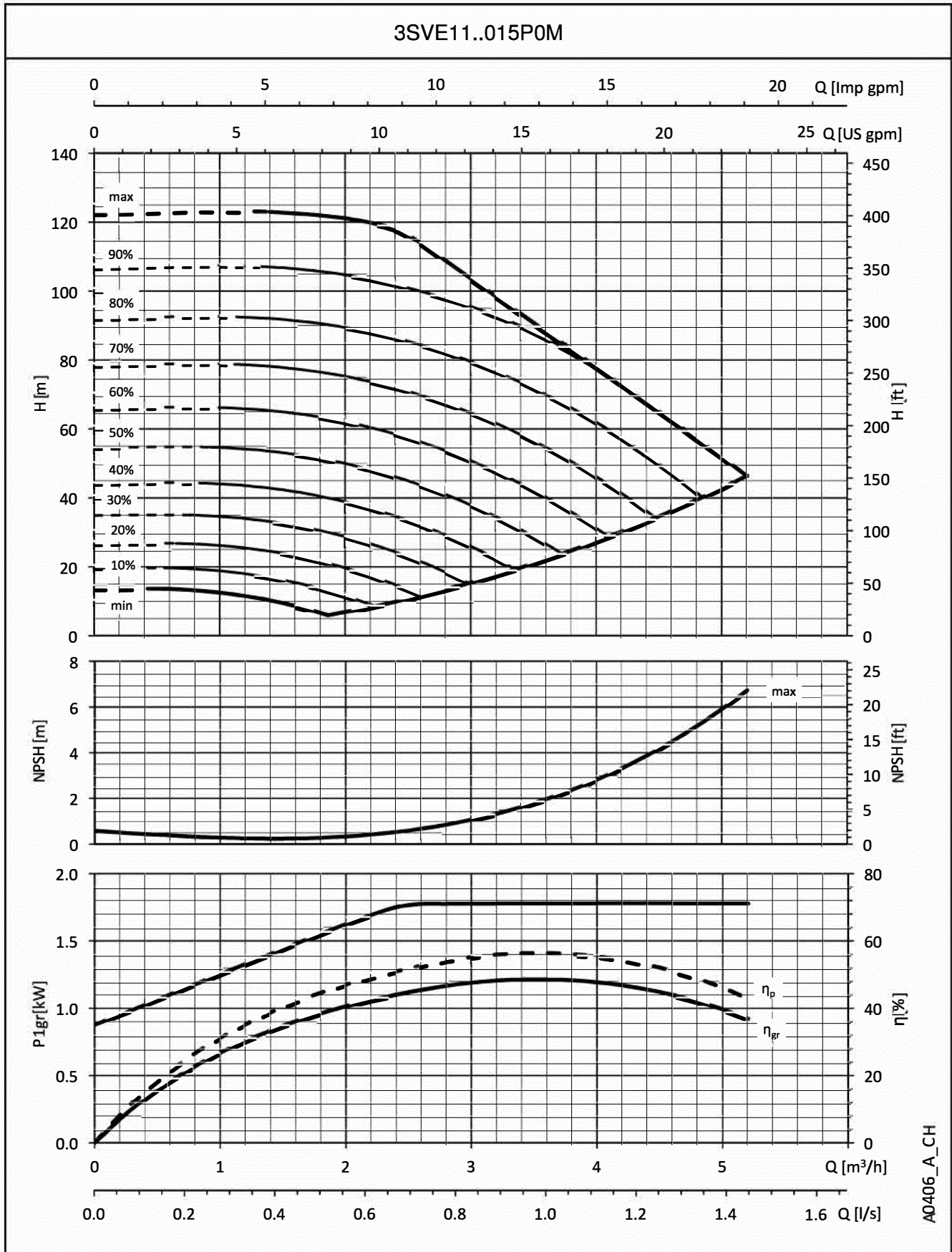

A0406\_A\_CH

The performances are valid for liquid with density  $\rho = 1.0 \text{ Kg/dm}^3$  and kinematic viscosity  $\nu = 1 \text{ mm}^2/\text{sec}$ .

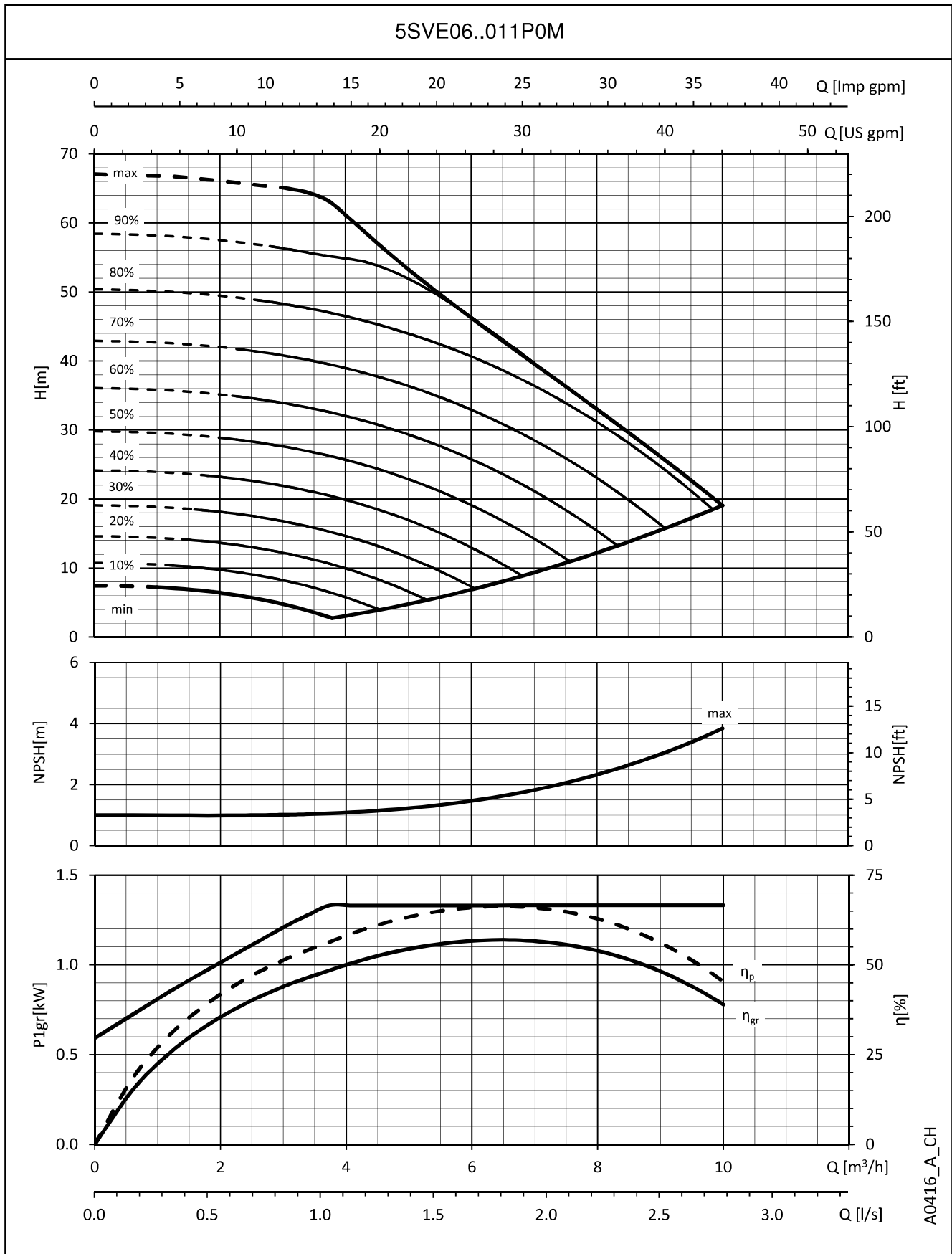
**5SVE SERIES  
OPERATING CHARACTERISTICS**

A0416\_A\_CH

 The performances are valid for liquid with density  $\rho = 1.0 \text{ Kg/dm}^3$  and kinematic viscosity  $\nu = 1 \text{ mm}^2/\text{sec}$ .

### 5SVE SERIES OPERATING CHARACTERISTICS

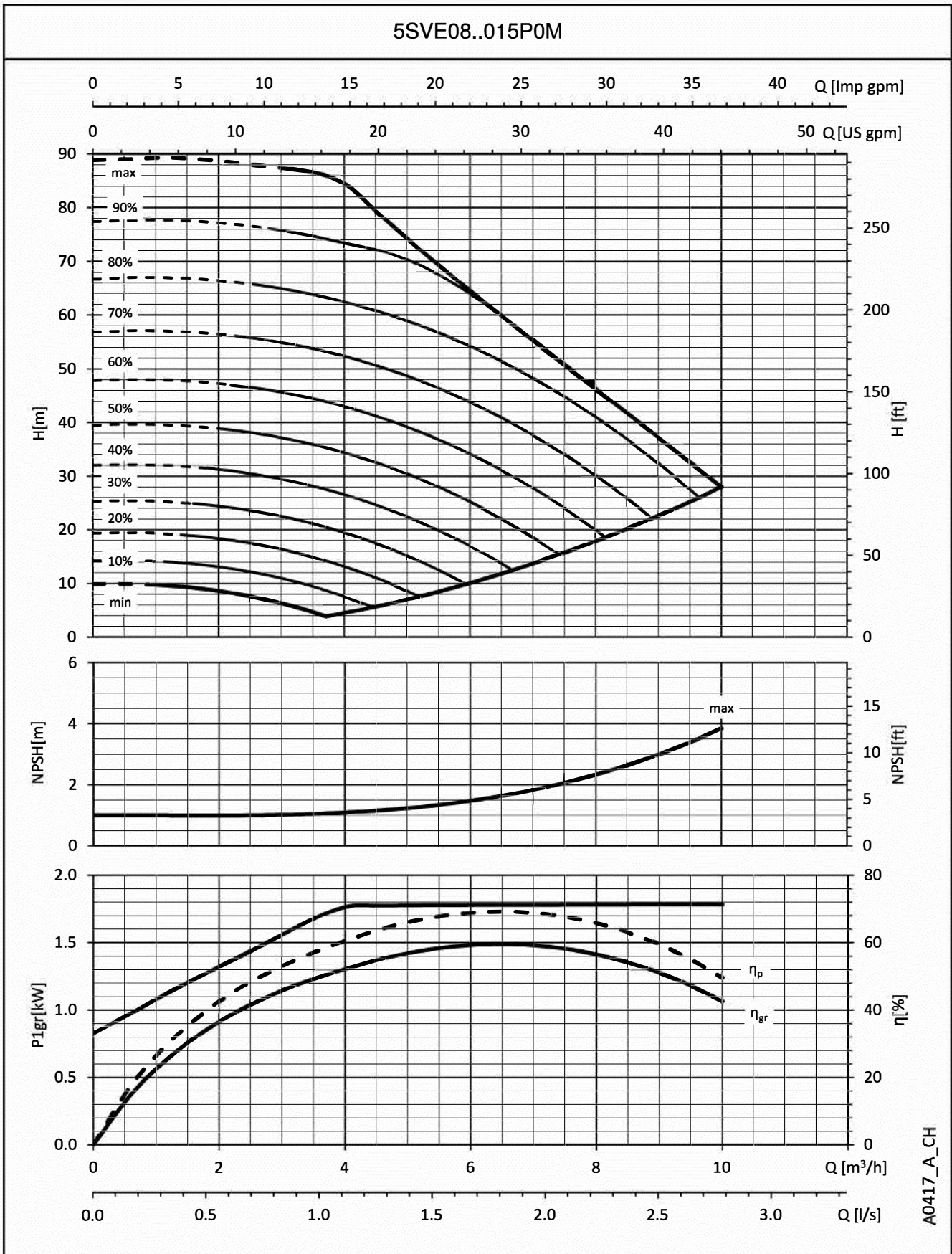

A0417\_A\_CH

The performances are valid for liquid with density  $\rho = 1.0 \text{ Kg/dm}^3$  and kinematic viscosity  $\nu = 1 \text{ mm}^2/\text{sec}$ .

## 10, 15, 22SVE..F SERIES DIMENSIONS AND WEIGHTS

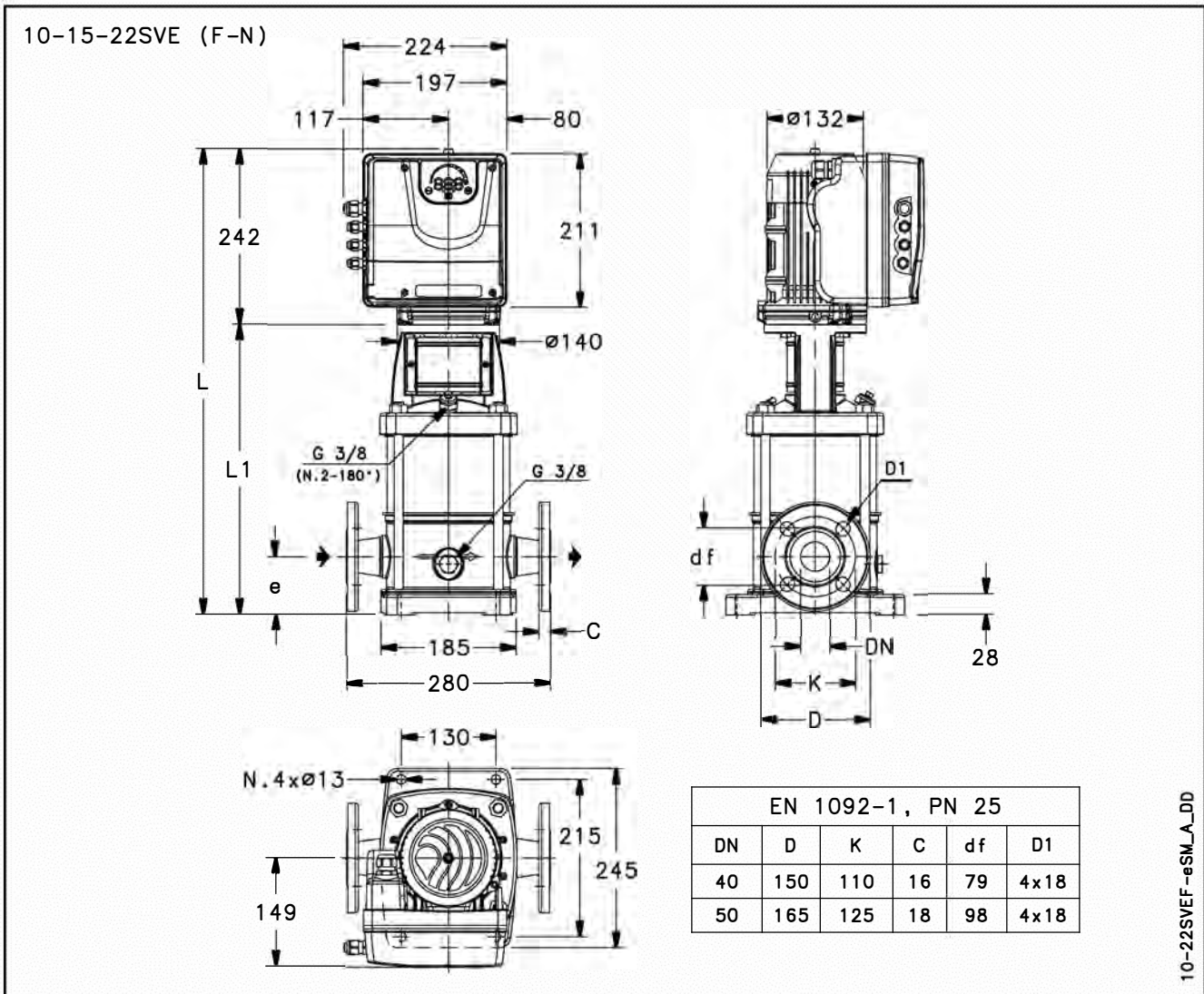

PUMP TYPE SVE F (SINGLE-PHASE)	MOTOR		DIMENSIONS (mm)				WEIGHT (kg)	
	kW	SIZE	L	L1	e	DN	PUMP	ELECTRIC PUMP
10SVE01F005POM	0,55	90	609	367	80	40	14,6	22,1
10SVE02F007POM	0,75	90	609	367	80	40	15,5	23,0
10SVE02F011POM	1,1	90	609	367	80	40	15,5	24,4
10SVE03F015POM	1,5	90	641	399	80	40	16,5	25,4
15SVE01F007POM	0,75	90	661	419	90	50	15,4	22,9
15SVE01F011POM	1,1	90	661	419	90	50	15,4	24,3
15SVE02F015POM	1,5	90	661	419	90	50	16,8	25,7
22SVE01F007POM	0,75	90	661	419	90	50	15,4	22,9
22SVE01F011POM	1,1	90	661	419	90	50	15,4	24,3
22SVE02F015POM	1,5	90	661	419	90	50	16,8	25,7

# 10SVE SERIES OPERATING CHARACTERISTICS

10SVE03..015P0M

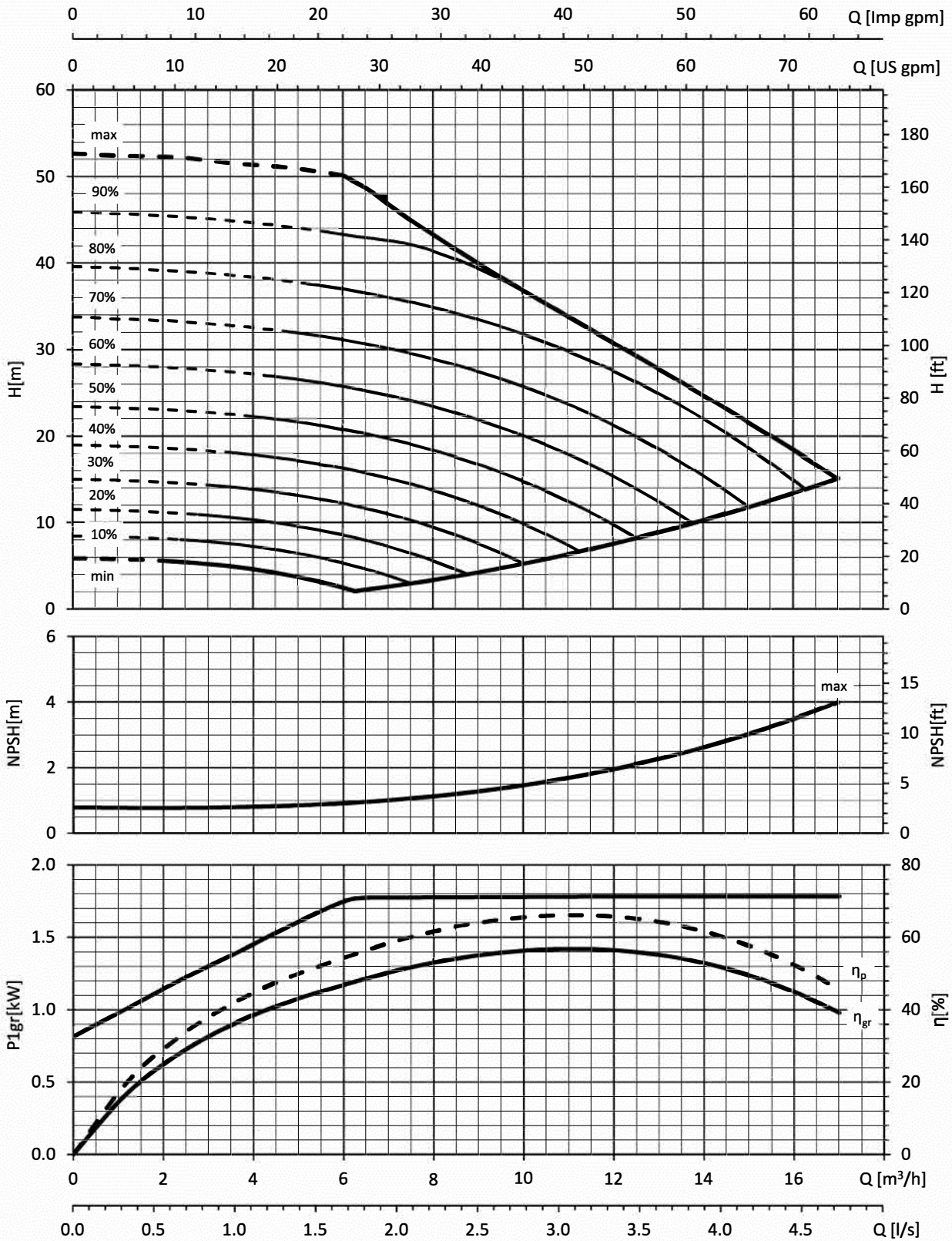

A0427\_A\_CH

The performances are valid for liquid with density  $\rho = 1.0 \text{ Kg/dm}^3$  and kinematic viscosity  $\nu = 1 \text{ mm}^2/\text{sec}$ .



At Brown Brothers Engineers, we have a whole range of variable speed drives and booster systems available for any application.

- SteadyPres booster systems



- Hydrovar single and dual booster systems



- Custom multiple pump systems



# Xylem |'zīləm|

- 1) The tissue in plants that brings water upward from the roots;
- 2) a leading global water technology company.

We're a global team unified in a common purpose: creating advanced technology solutions to the world's water challenges. Developing new technologies that will improve the way water is used, conserved, and re-used in the future is central to our work. Our products and services move, treat, analyze, monitor and return water to the environment, in public utility, industrial, residential and commercial building services, and agricultural settings. With its October 2016 acquisition of Sensus, Xylem added smart metering, network technologies and advanced data analytics for water, gas and electric utilities to its portfolio of solutions. In more than 150 countries, we have strong, long-standing relationships with customers who know us for our powerful combination of leading product brands and applications expertise with a strong focus on developing comprehensive, sustainable solutions.



1300 4 BBENG  
[www.brownbros.com.au](http://www.brownbros.com.au)



0508 4 BBENG  
[www.brownbros.co.nz](http://www.brownbros.co.nz)