

Goulds GSC Series

Horizontal Double
Suction Split Casing
Pumps

Goulds Pumps



ITT Industries
Engineered for life



GSC 500 - 50 A

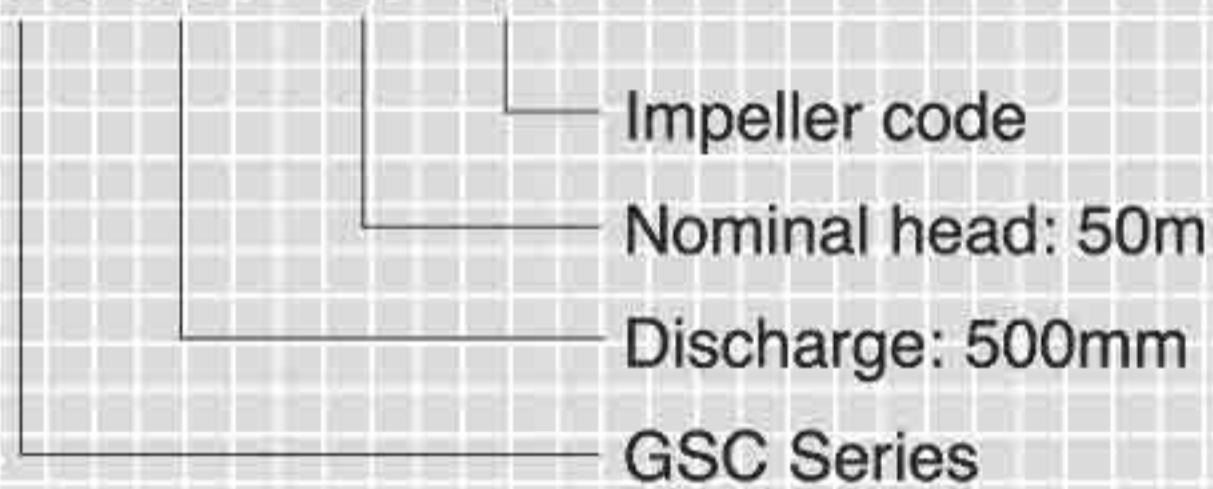

Energy saving high efficiency
Low pulsation unique design
High reliability
Less maintenance
Easy dismantling

Goulds GSC Series

**Double Suction Split Casing Pumps
Designed for Wide Range of
Applications.**

- Capacities: up to 18000m³/h
- Heads: up to 180 m
- Temperatures: up to 105°C
- Pressures: up to 10 Bar
(special version up to 25 Bar)
- Efficiency: up to 92.5%
- Speed: up to 2970rpm
- Suction: DIN150-DIN1200
- Discharge: DIN100-DIN1000
40 Sizes available

Design Features

- **Durable design**
- **High efficiency**
- **Low pulsation**
- **Various material of construction**
- **Gland packing or single/double mechanical seal arrangement**
- **Replaceable wear rings & shaft sleeve**

Applications

- **Water Supply** Primary lift and secondary booster stations
- **Building Service** HVAC water transfer & District heating systems
- **Agriculture** Irrigation drainage and flood control
- **Industry** power plant filtration, water treatment, filtration and cleaning in pulp and paper
- **Marine** Cooling system and fire fighting

Cross Sectional View

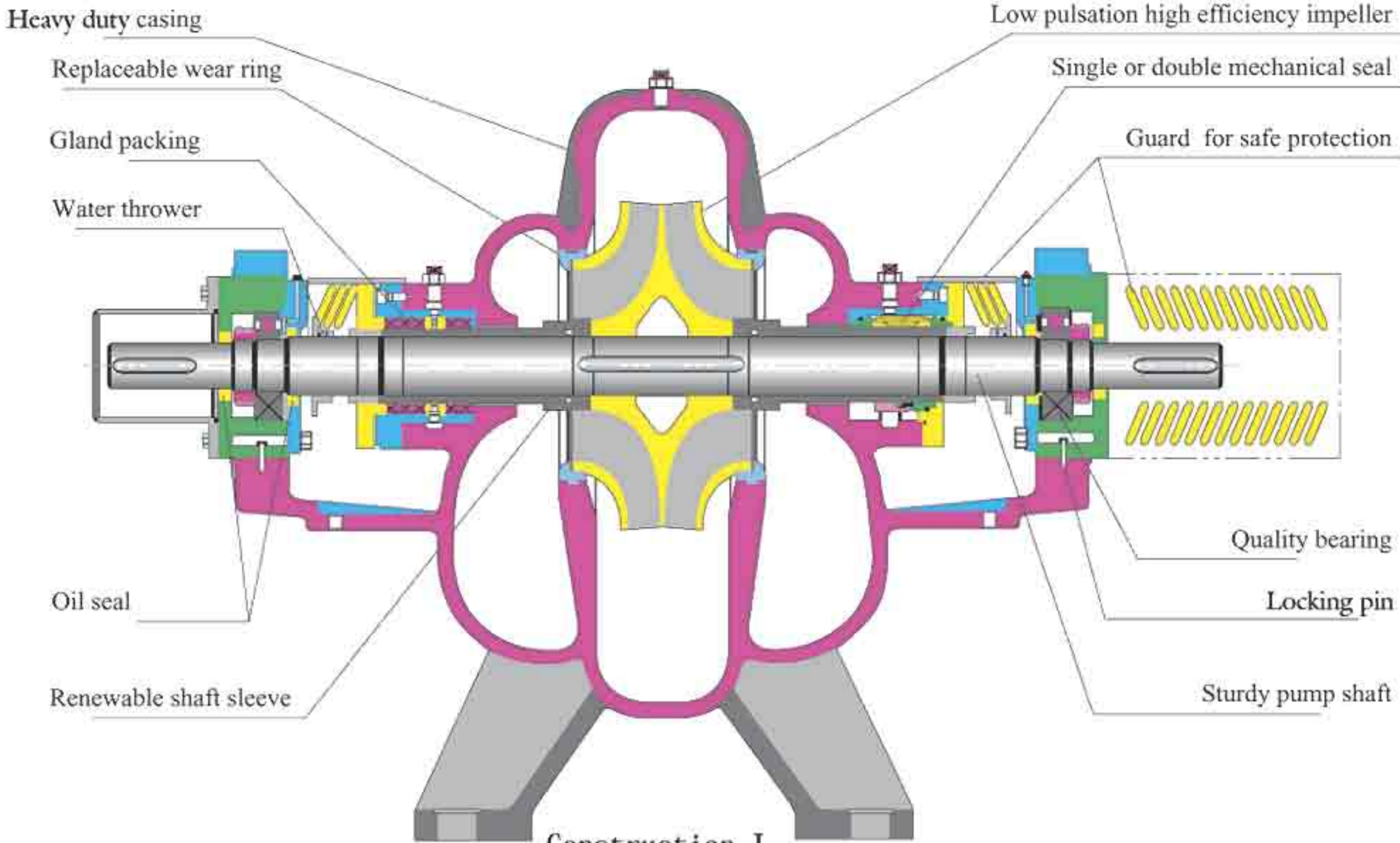

Construction I

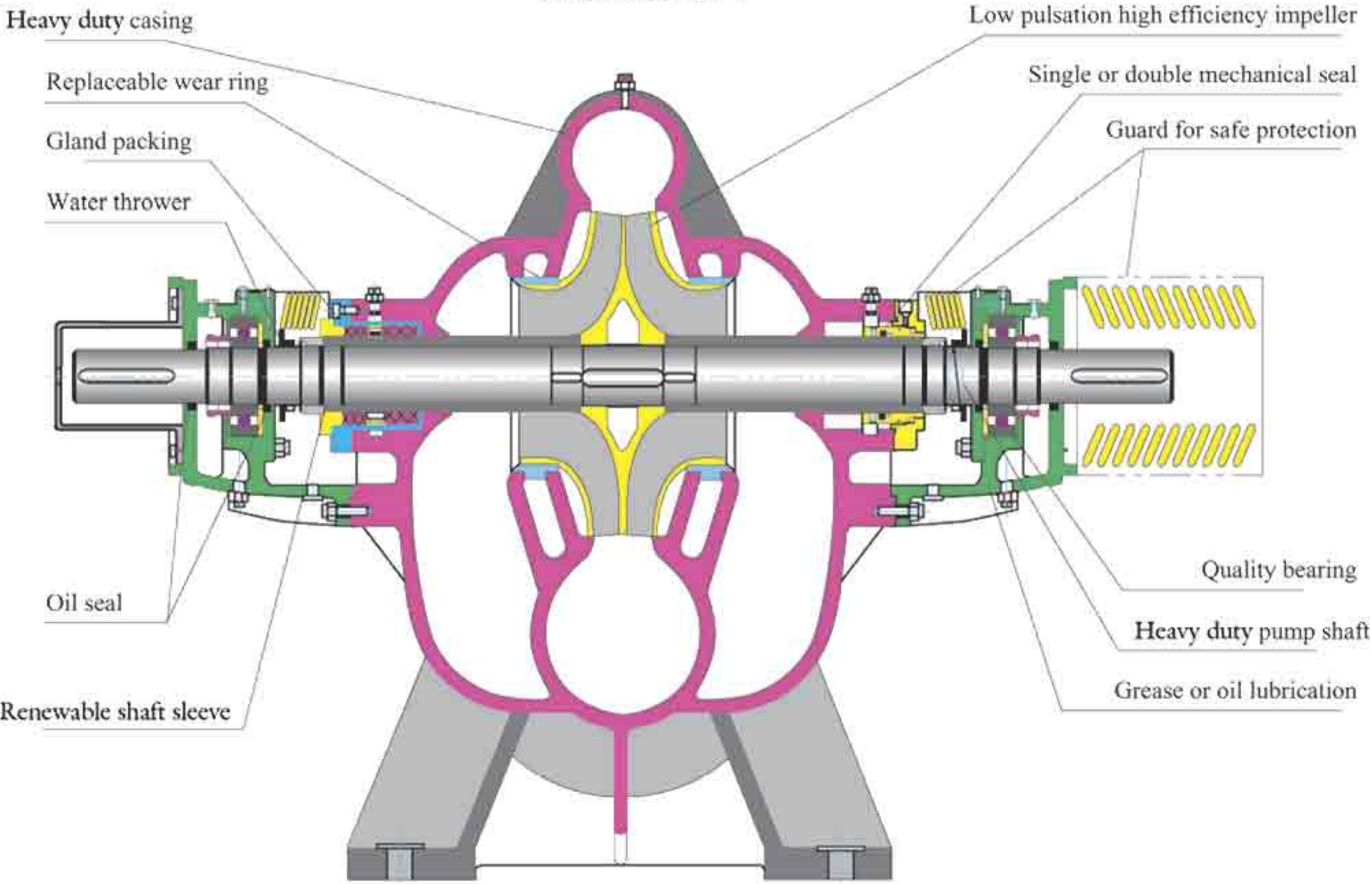

Construction II



Impeller

Bi-directional rotation and radial balance assure highly efficient performance.

Heavy Duty Casing

Durable foot-mounted and design to resist external forces and vibration.

Replaceable Wear Ring

Easily replaceable construction permits handy maintenance of proper running clearance for maximum efficiency operation.

Bearing Housing

High quality and provides a solid support for the bearing.

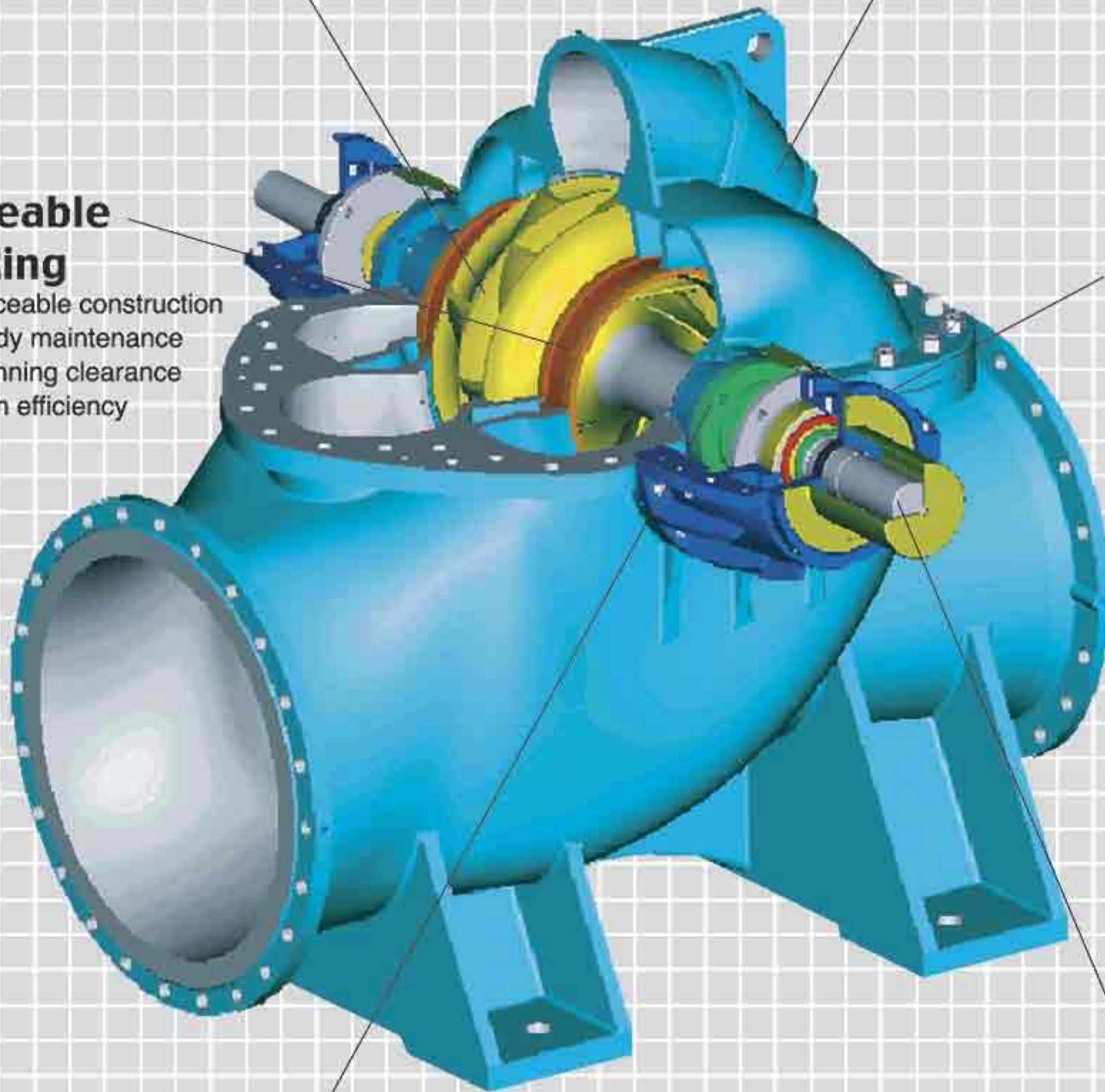

Shaft Sealing by Either Gland Packing or Mechanical Seal

The shaft can be sealed by either gland packing or mechanical.

Heavy Duty Shaft

Solid intensity Shaft provides high thrust and heavy-duty capability.

Specifications

- **Excellent Hydraulic Profile**

Using latest 3-D CAD and Computational Fluid Dynamics(CFD) analysis ensures optimum hydraulic profile.

- **Double-flow Impeller**

Owing to its unique and innovative design, optimum flow behaviour is guaranteed and thus the impeller features low NPSH requirement, low pulsation and high efficiency

- **Shaft Tailored for Two-sided Drive**

Heavy duty shaft with minimum deflection is designed to ensure vibration free operation. Two-sided drive provides the flexibility of installation requirement.

- **Shaft Seal**

There are options on the sealing arrangements to meet different applications.

- **Diaphragm Coupling**

It gives significant loading capacity, high damping and excellent compensation for optional misalignment between the motor shaft and pump shaft.



Gland packing

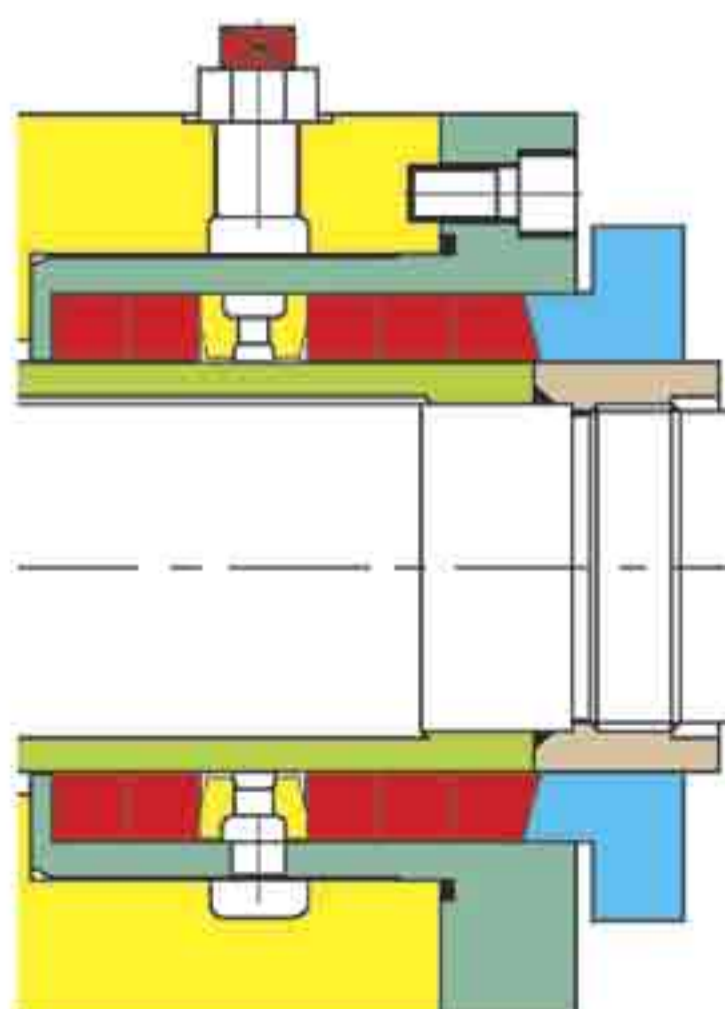

Single mechanical seal

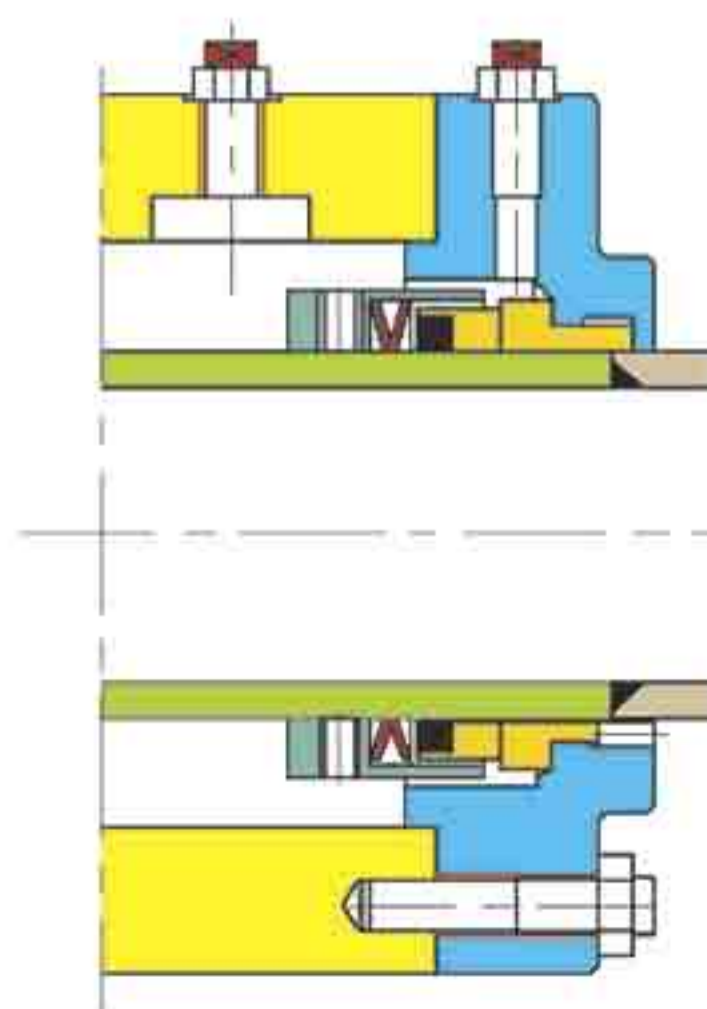

Double mechanical seal

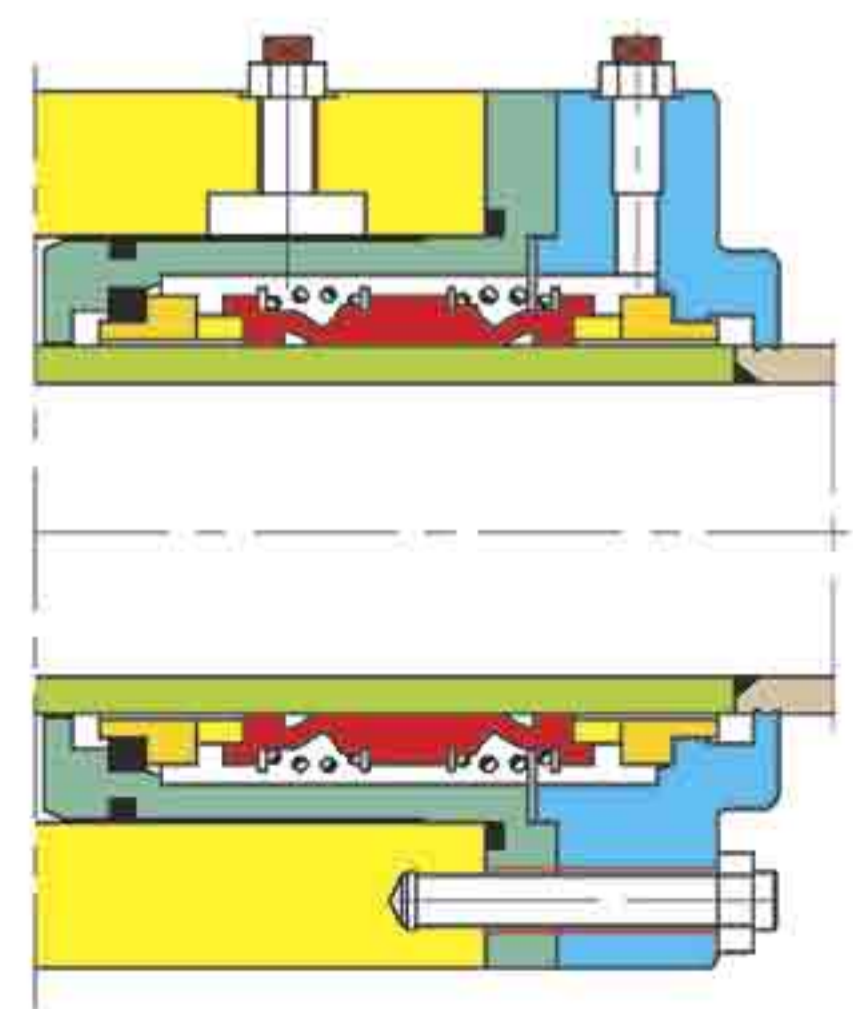



Technical Characteristics

Material of Construction

Part Description	Materials of Construction			Part Description	Materials of Construction		
	All Iron	Bronze Fitted	All Stainless Steel		All Iron	Bronze Fitted	All Stainless Steel
Casing	GG25	GG25	1.4460	Seal chamber	GG25	GG25	SS316
Impeller	GG25	LG2	1.4460	Gland cover	GG25	GG25	SS316
Shaft	41Cr4	SS420	1.4462	Lantern ring	GG25	GG25	SS316
Shaft sleeve	SS420	LG2	1.4460	Water thrower	SS420	SS420	SS420
Wear ring	GG25	LG2	1.4460	Bearing Housing	GG25	GG25	GG25
Lock nut	C45E	SS420	SS420	Fastener	mild steel	SS304	SS304

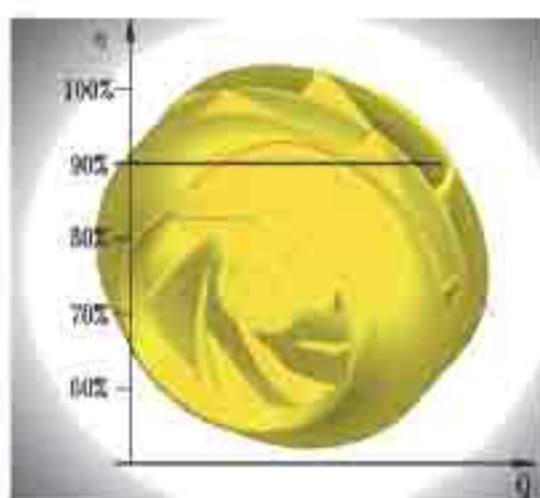



Unique Hydraulic Design



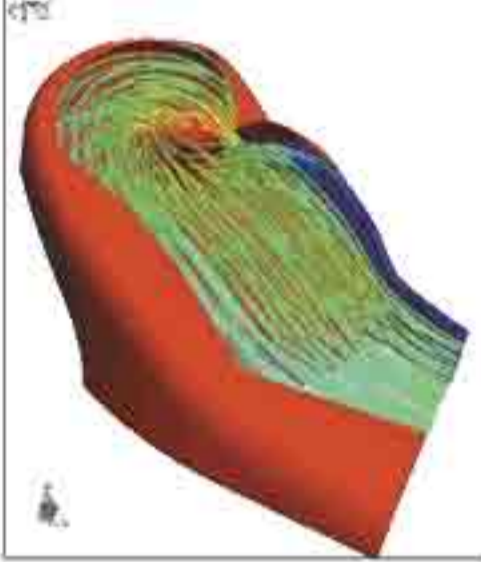

The maximum efficiency with up to 92.5% & wide HE operation range and the lowest NPSH requirement are ensured by the use of following tools:

- Up to the minute hydraulic research findings.
- Computational Fluid Dynamics calculation
- 3-D CAD Pro-E

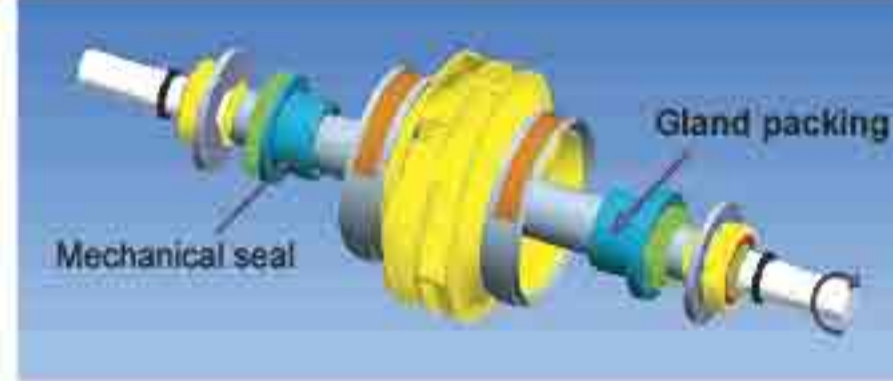
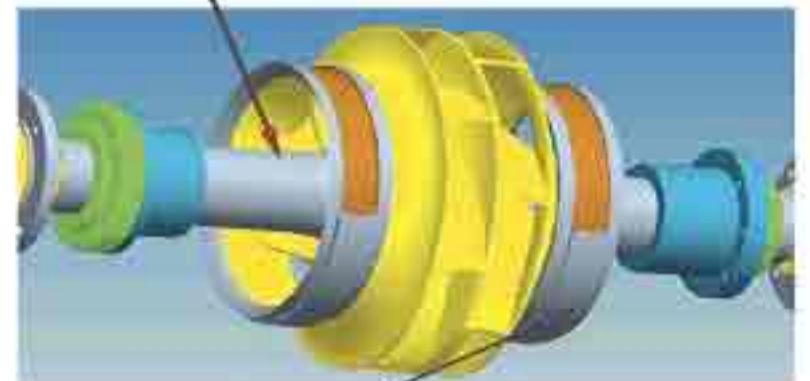
Construction Characteristics

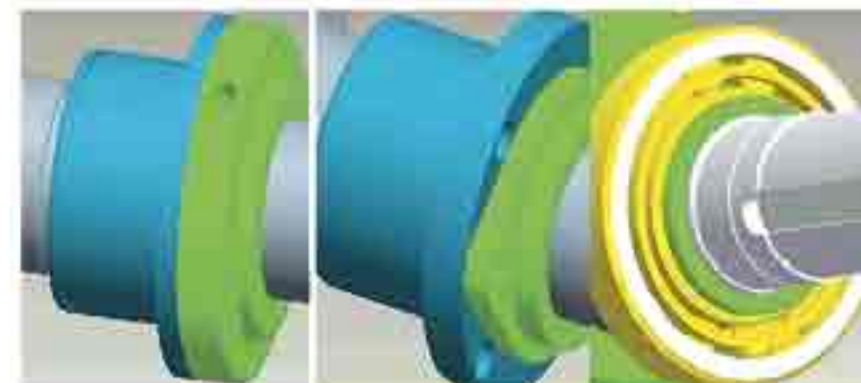
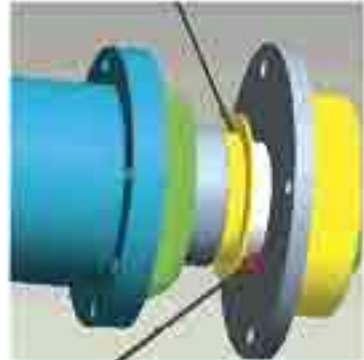
 <p>Optimum hydraulic model</p> <ul style="list-style-type: none"> ▪ Innovative of hydraulic development ▪ Hydraulic pattern goes through test simulation ▪ Maximum efficiency and optimal flow behavior towards lowest NPSH 	 <p>Smooth casting surface contributes to performance expectation</p>
---	--

	 <p>Mechanical seal Gland packing</p>	<p>Replaceable shaft sleeves protect the pump shaft</p>  <p>Replaceable wear rings</p>
<p>Double-flow impeller</p> <ul style="list-style-type: none"> ▪ Low pulsation -offset blades ▪ Nil axial thrust -Two halves symmetrically combined, gives hydraulically balance 	<p>Low vibration and deflection- in between bearing design, dynamically balanced heavy duty shaft</p> <p>Two-sided drive---The pump can be driven from either right or left side.</p>	<p>Replaceable wear rings</p>

<p>Quality seal & bearing</p>			<p>Multi-protection for bearing</p>	<p>Separate sealing chamber</p>	<p>Low spares requirement</p>		
<p>Mechanical seal Burgmann as standard</p>	<p>Soft packing Carbonized fibre</p>	<p>Bearing NSK or SKF</p>	<p>SS water thrower and O ring as primary protection</p>	<p>Easy dismantling and change between packing and mech.seal</p>	<p>Impeller</p>	<p>Mechanical seal or packing</p>	<p>Wear rings</p>
			 <p>Oil seal further prevents dust or water ingress</p>	 <p>Split type gland makes maintenance easy</p>			



GSC Series– Dimensions and Weight

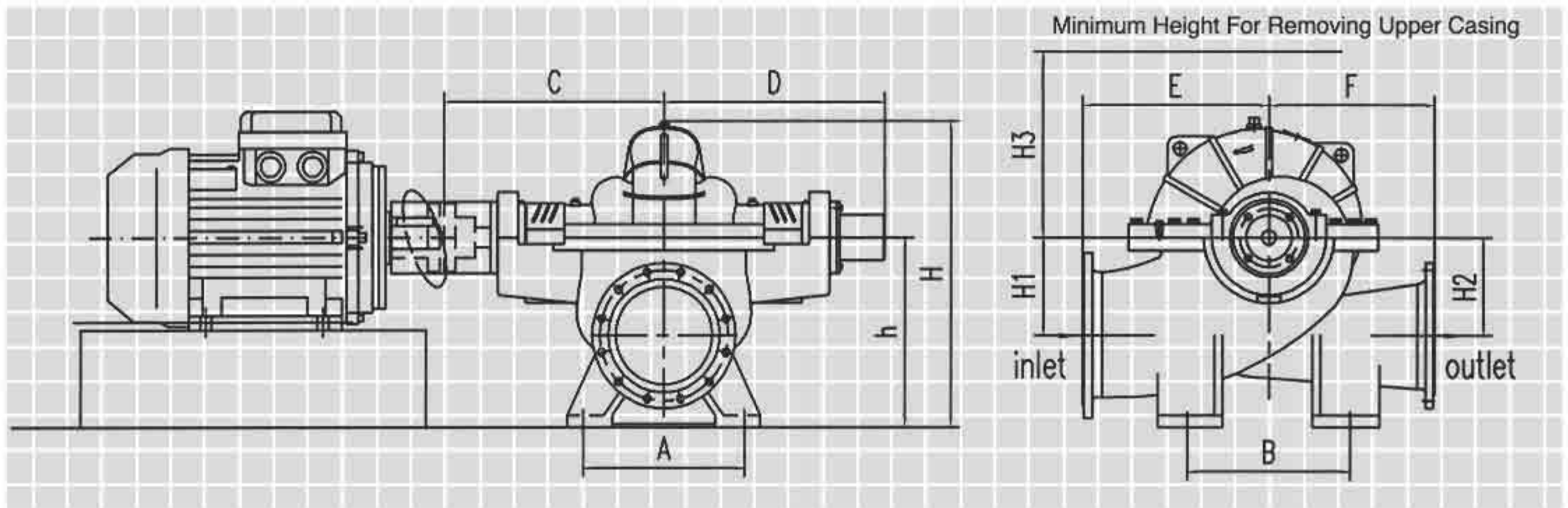

No.	Type	Suction	Discharge	A	B	C	D	E	F	h	H	H1	H2	H3	Weight
1	300-10	300	300	450	550	535	581	500	500	510	808	265	265	434	500
2	500-10	500	500	580	800	717.5	738.5	775	775	800	1251	410	410	656	1280
3	200-15	250	200	350	450	485	510	415	330	450	709	210	215	390	305
4	350-15	350	350	500	600	620	634	584	584	620	970	310	310	504	755
5	250-20	300	250	450	550	537	559	500	400	510	803	250	260	446	445
6	400-20	500	400	580	800	750	787	820	640	800	1266	410	410	703	1740
7	600-20	700	600	850	850	935	973	900	800	1050	1622	534	514	960	2640
8	700-20	800	700	1000	1200	1010	1048	1200	1000	1200	1845	605	605	957	3330
9	200-25	250	200	350	400	501	539	450	400	450	738	230	230	450	375
10	300-25	350	300	500	600	632	659	580	460	620	963	290	300	530	690
11	100-30	150	100	250	270	419	442	270	250	320	474	150	140	260	150
12	150-30	200	150	280	280	453	481	285	285	370	565	170	150	298	180
13	250-30	300	250	450	450	610	624	470	410	510	824	260	270	500	550
14	300-35	350	300	500	500	675	717	570	510	620	982	300	300	572	895
15	350-35	500	350	580	800	756	768	720	630	800	1270	415	415	752	1350
16	150-40	200	150	250	250	415	442	320	300	355	547	170	170	304	205
17	200-40	250	200	350	400	511	549	450	440	450	745	200	260	483	390
18	100-50	150	100	280	280	400	432	300	250	285	435	140	140	265	160
19	350-50	400	350	700	700	768	781	605	580	670	1055	335	400	615	1460
20	500-50	700	500	850	850	955	993	900	760	1050	1624	547	547	900	2320
21	700-50	800	700	1000	1200	1150	1203	1100	1000	1200	1868	590	590	1005	4190
22	900-50	1000	900	1200	1300	1305	1328	1350	1200	1450	2400	772.5	772.5	1388	8160
23	1000-50	1200	1000	1460	1600	1455	1478	1742	1340	1750	2750	944.5	944.5	1488	9780
24	150-60	200	150	280	280	410	437	320	300	355	544	170	170	315	210
25	250-60	300	250	450	550	626	643	540	530	510	852	250	310	572	575
26	500-60	700	500	850	850	970	1008	900	780	1050	1650	579	579	955	3250
27	150-65	250	150	450	550	603	624	480	400	510	856	240	290	575	500
28	250-65	350	250	500	500	709	724	650	600	620	1118	274	356	766	1225
29	400-70	500	400	700	750	905	943	690	600	800	1267	441	441	735	1840
30	700-70	800	700	1000	1200	1225	1278	1050	1100	1250	1946	670	670	1092	4290
31	800-70	1000	800	1460	1500	1360	1383	1380	1200	1600	2510	882	882	1430	8850
32	100-80	150	100	250	270	401	410	300	250	285	455	140	155	305	175
33	200-90	300	200	450	450	674	701	576	470	510	898	268	325	666	760
34	900-90	1200	900	1750	1500	1570	1599	1800	1360	1800	2840	985	985	1620	12300
35	125-95	200	125	280	280	475	516	350	330	355	555	170	170	353	255
36	700-105	900	700	1000	1200	1325	1348	1250	1080	1370	2150	755	755	1227	6650
37	500-115	600	500	940	860	1170	1223	950	810	1000	1555	523	523	873	3200
38	200-125	350	200	500	600	775	787	660	550	620	1080	330	410	800	1450
39	200-130	300	200	450	600	705	731	630	500	620	1040	325	325	745	1600
40	150-140	200	150	350	390	515	545	380	320	425	650	188	188	403	450

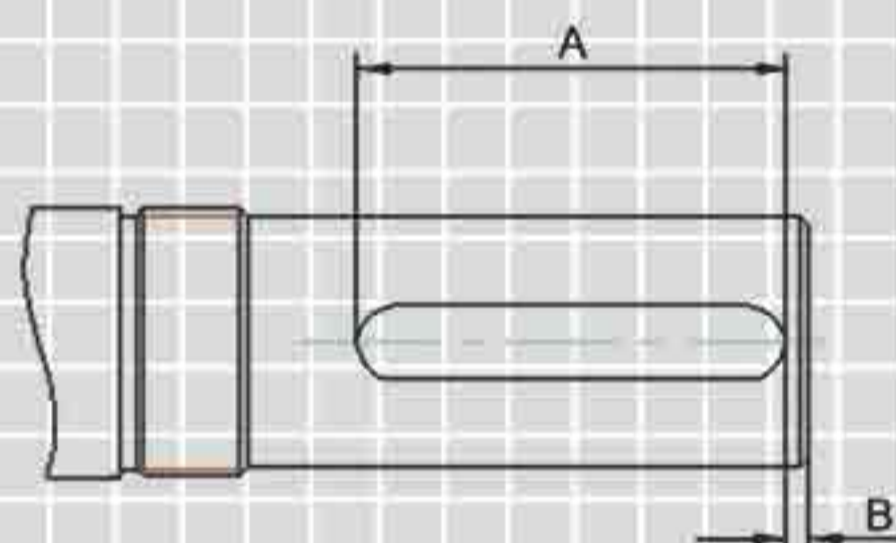
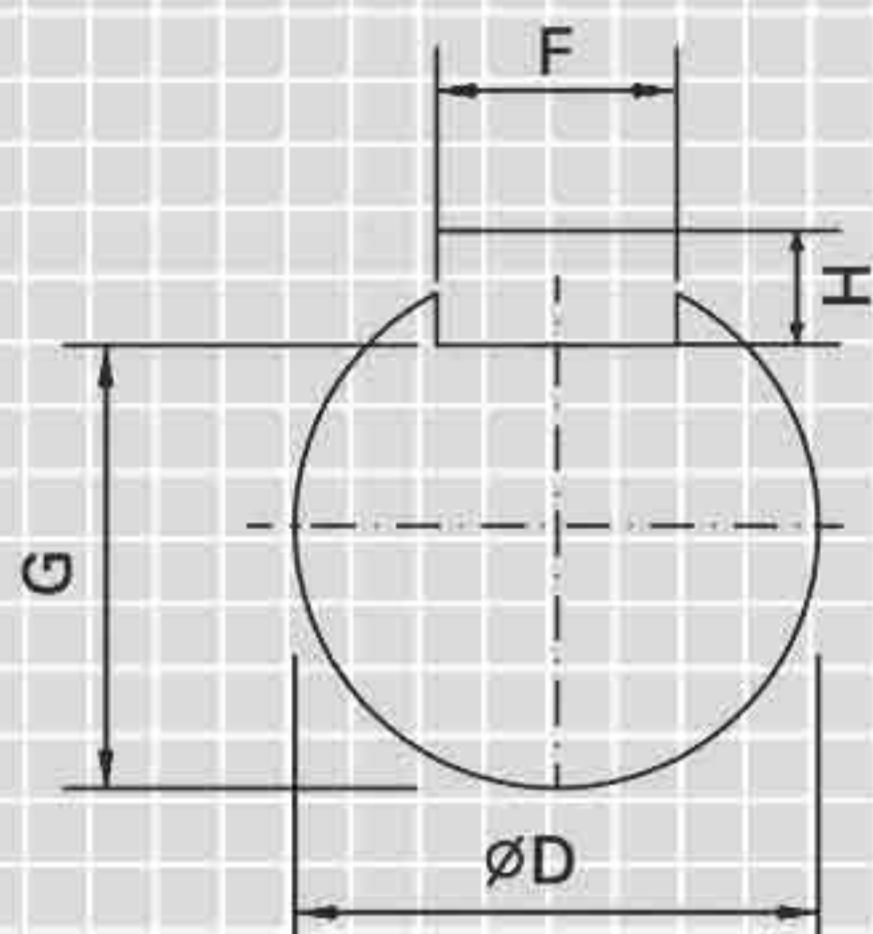

Shaft End Dimensions

No.	Type	A	B	D	G	F	H	No.	Type	A	B	D	G	F	H
1	300-10	80	5	40	35	12	8	21	700-50	220	5	115	104	32	18
2	500-10	100	5	50	44.5	14	9	22	900-50	250	5	155	142	40	22
3	200-15	63	5	30	26	8	7	23	1000-50	250	5	155	142	40	22
4	350-15	90	5	40	35	12	8	24	150-60	60	5	30	26	8	7
5	250-20	60	5	40	35	12	8	25	250-60	100	5	50	44.5	14	9
6	400-20	100	5	60	53	18	11	26	500-60	180	5	85	76	22	14
7	600-20	180	5	85	76	22	14	27	150-65	100	5	50	44.5	14	9
8	700-20	180	5	85	76	22	14	28	250-65	125	5	60	53	18	11
9	200-25	60	5	40	35	12	8	29	400-70	180	5	85	76	22	14
10	300-25	100	5	50	44.5	14	9	30	700-70	220	5	115	104	32	18
11	100-30	63	5	30	26	8	7	31	800-70	250	5	155	142	40	22
12	150-30	63	5	30	26	8	7	32	100-80	63	5	30	26	8	7
13	250-30	100	5	50	44.5	14	9	33	200-90	125	5	60	53	18	11
14	300-35	100	5	60	53	18	11	34	900-90	280	5	185	170	45	25
15	350-35	120	5	50	53	18	11	35	125-95	80	5	40	35	12	8
16	150-40	60	5	30	26	8	7	36	700-105	250	5	155	142	40	22
17	200-40	60	5	40	35	12	8	37	500-115	220	5	115	104	32	18
18	100-50	63	5	30	26	8	7	38	200-125	160	5	75	67.5	20	12
19	350-50	130	5	75	67.5	20	12	39	200-130	125	5	60	53	18	11
20	500-50	180	5	85	76	22	14	40	150-140	80	5	40	35	12	8

Flange Dimensions

Order	DN	d	K	N × f L	Pressure (kg/cm ³)
1	100	156	180	8 × f 18	10
2	125	184	210	8 × f 18	10
3	125	184	210	8 × f 18	16
4	150	211	240	8 × f 22	10
5	200	266	295	8 × f 22	10
6	200	266	295	12 × f 22	16
7	250	320	350	12 × f 22	10
8	300	370	400	12 × f 22	10
9	350	428	460	16 × f 22	10
10	350	429	470	16 × f 28	16
11	400	480	515	16 × f 28	10
12	500	582	620	20 × f 28	10
13	600	682	725	20 × f 31	10
14	700	794	840	24 × f 31	10
15	800	901	950	24 × f 34	10
16	900	1001	1050	28 × f 31	10
17	1000	1112	1160	28 × f 37	10
18	1200	1328	1380	32 × f 40	10

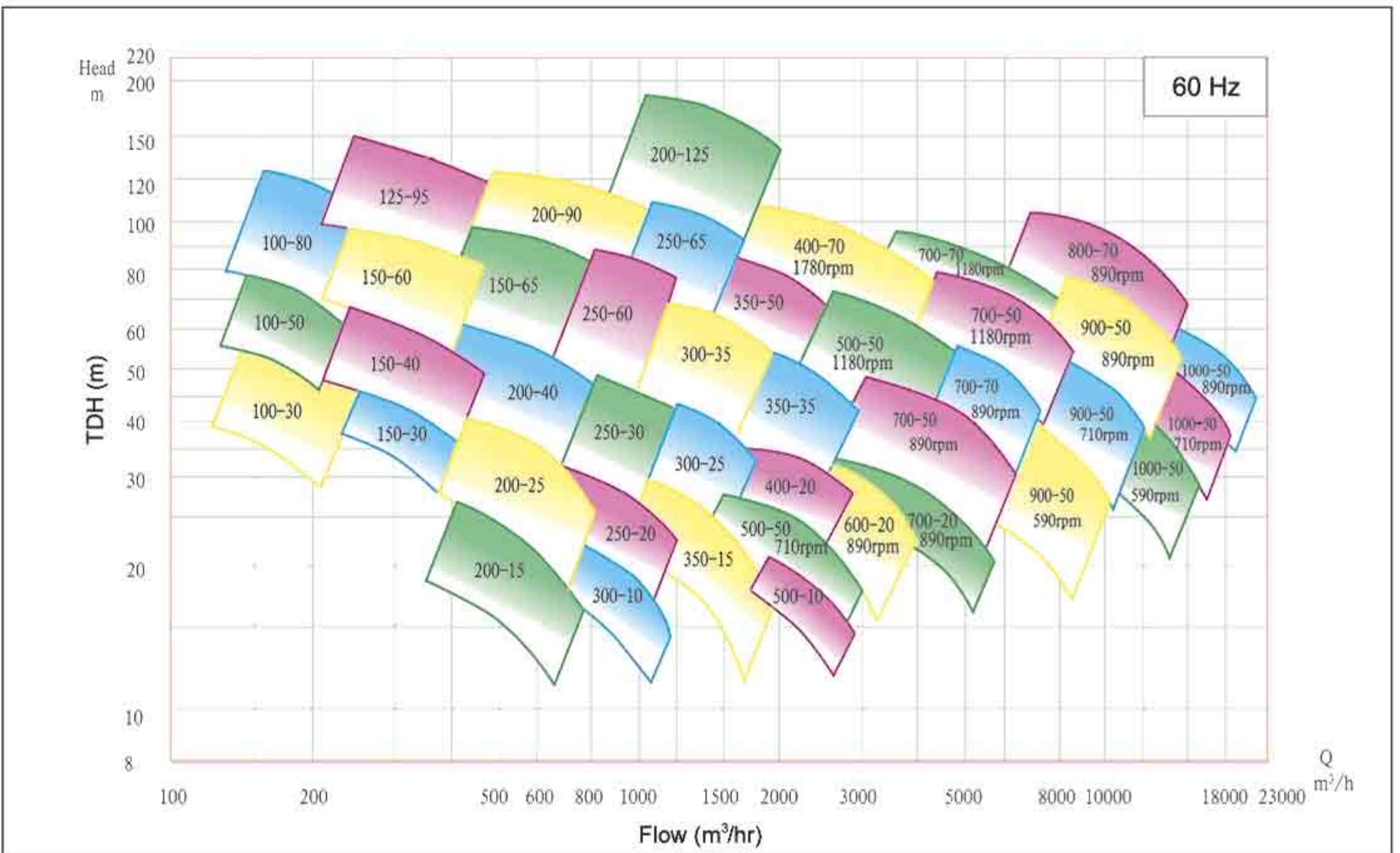
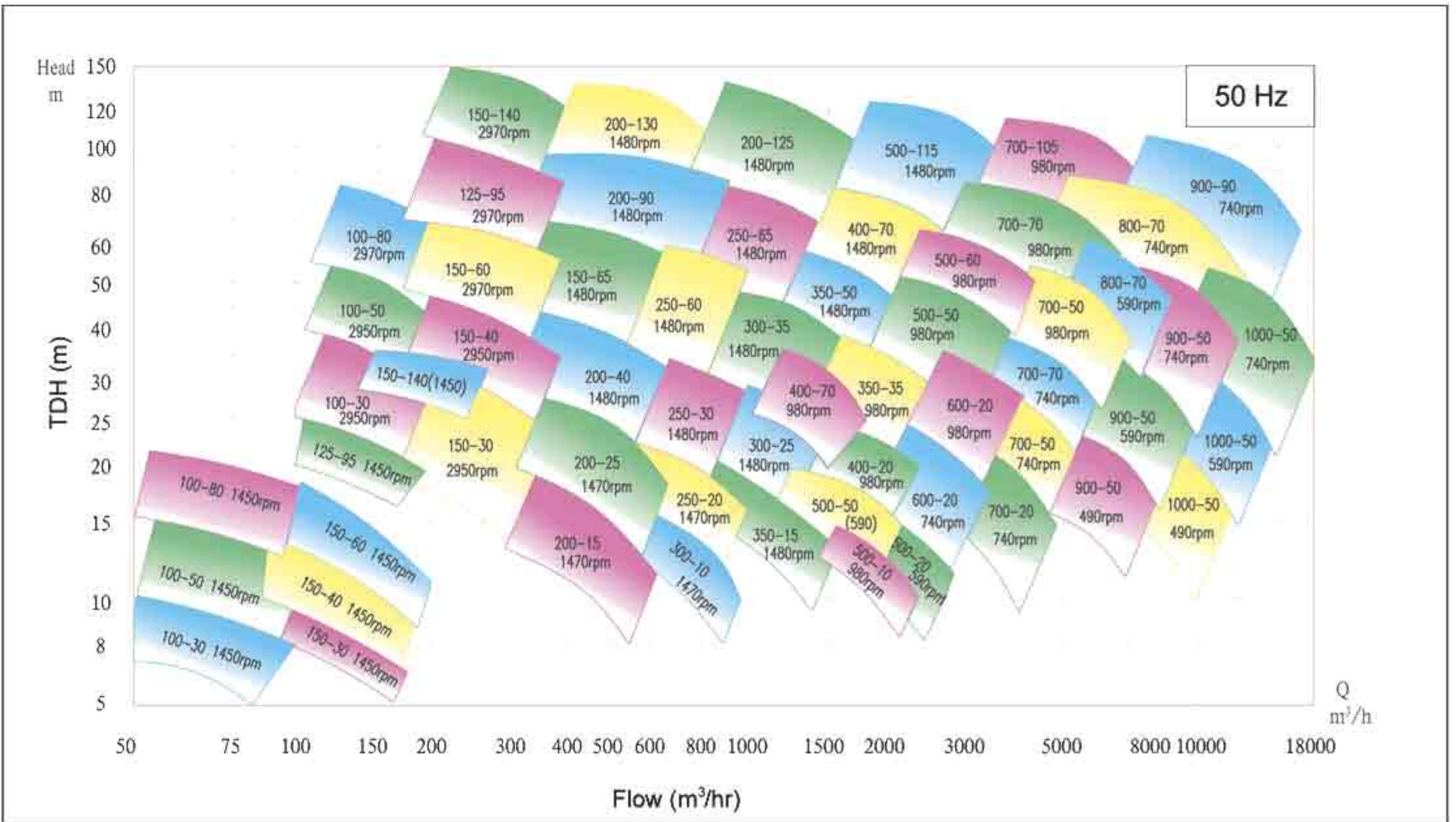

Performance Curves

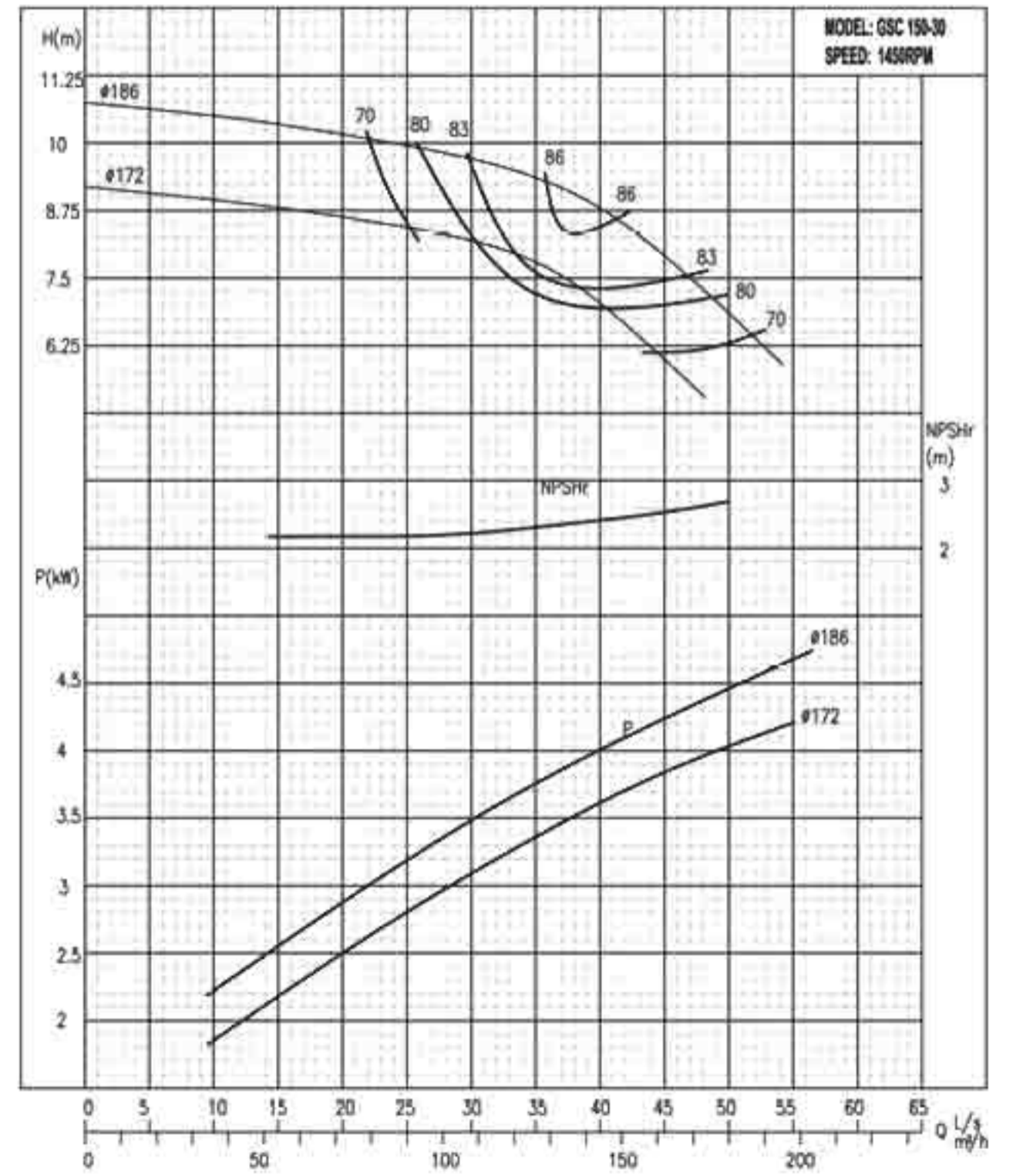
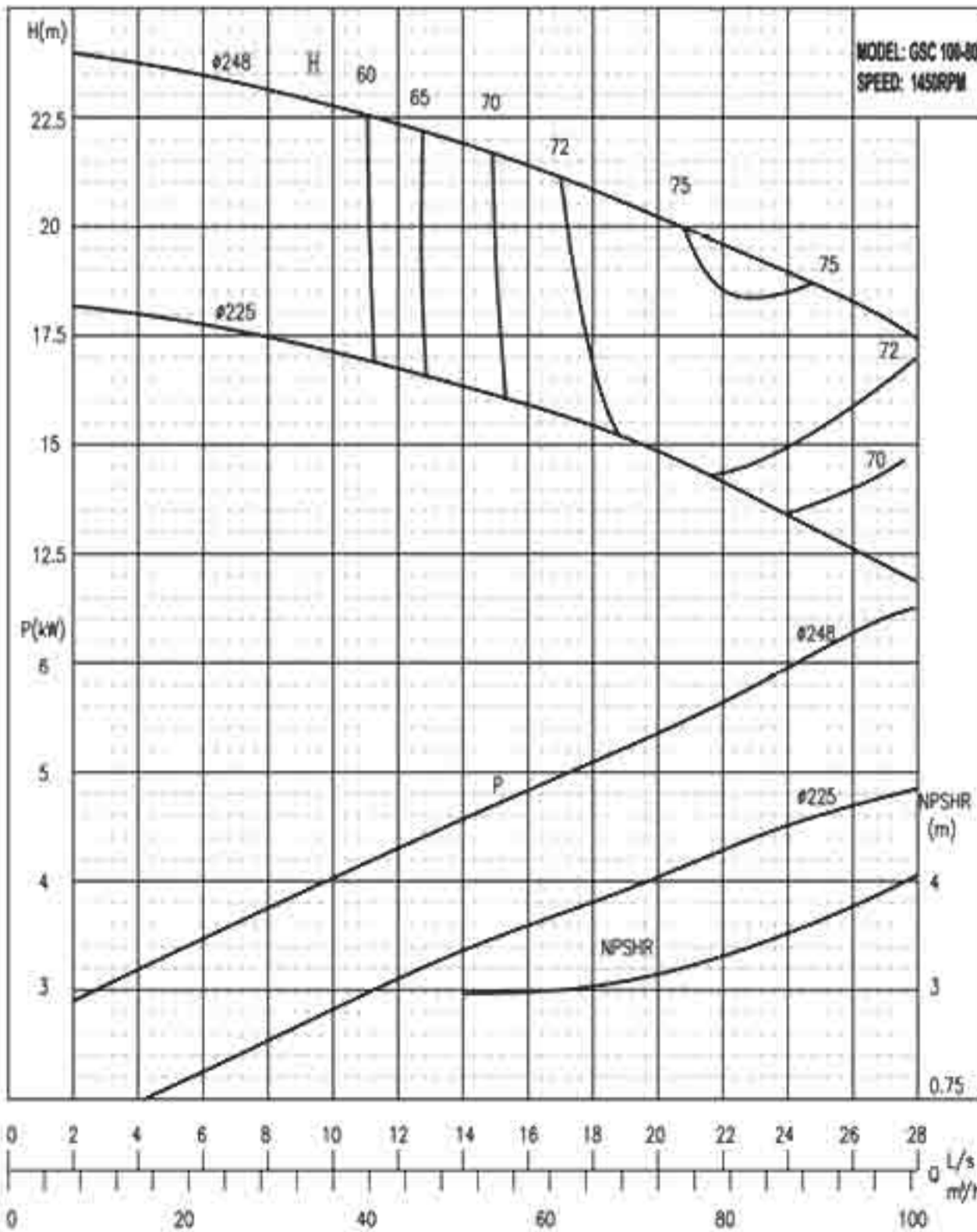
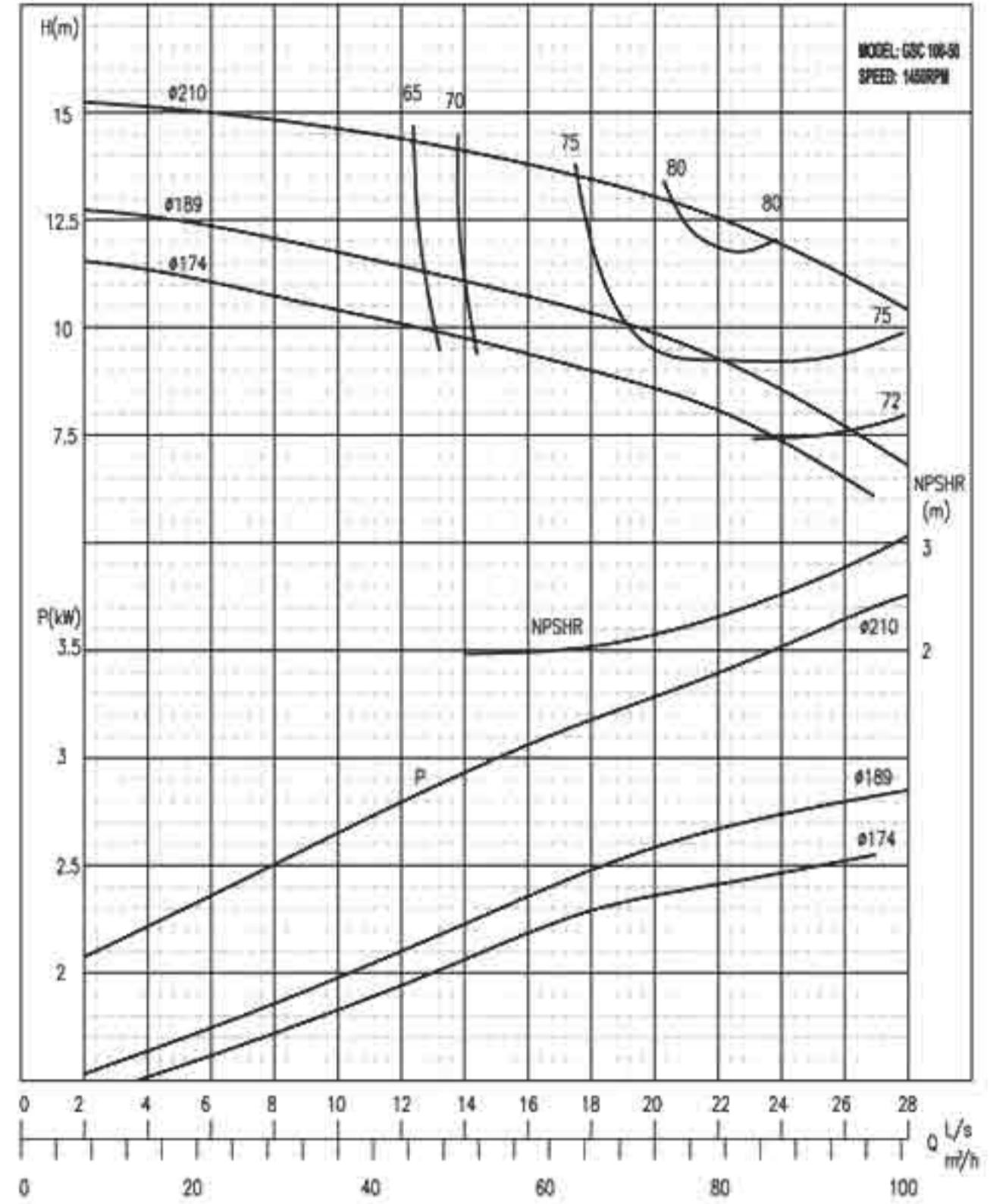
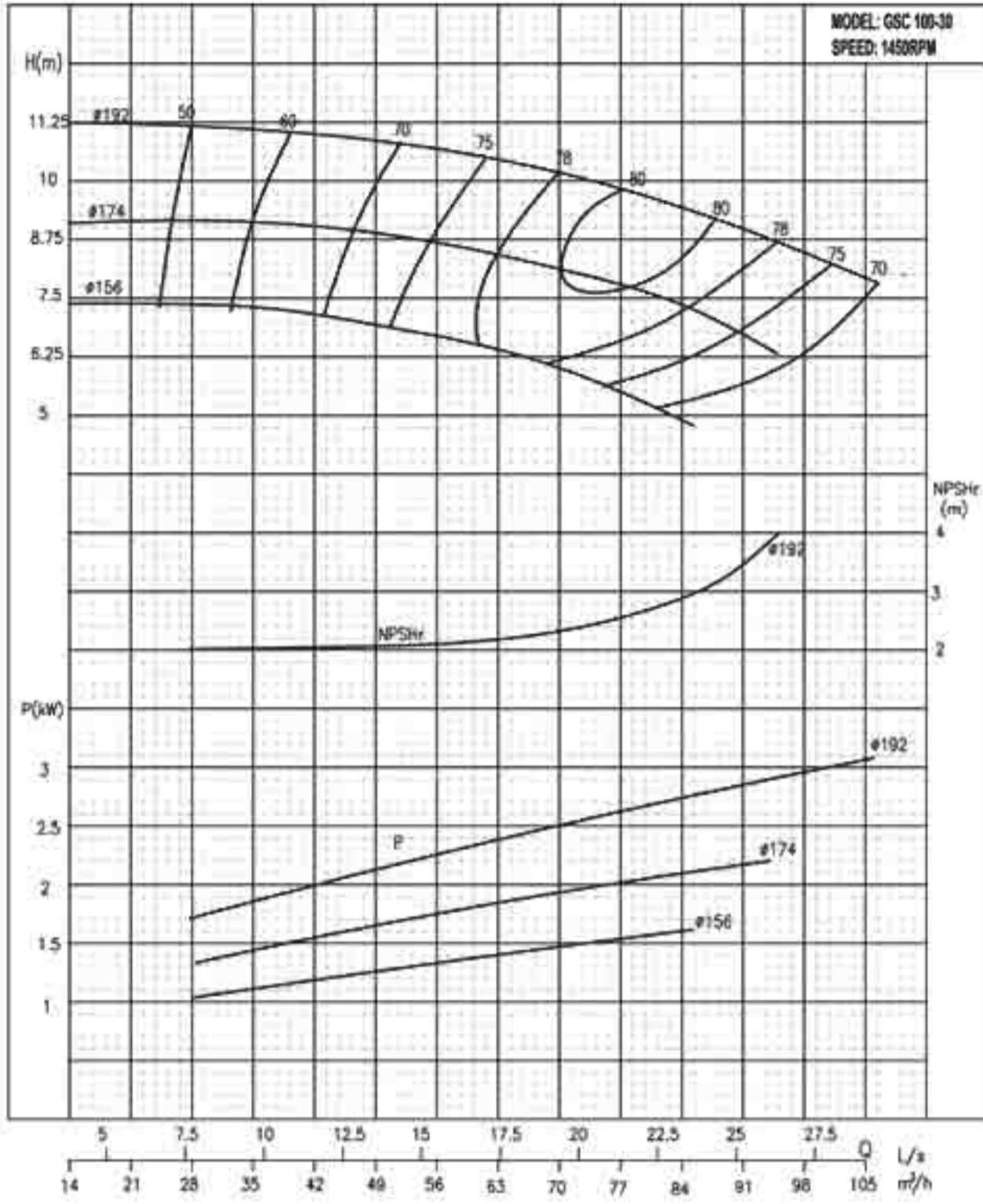



Performance Curves

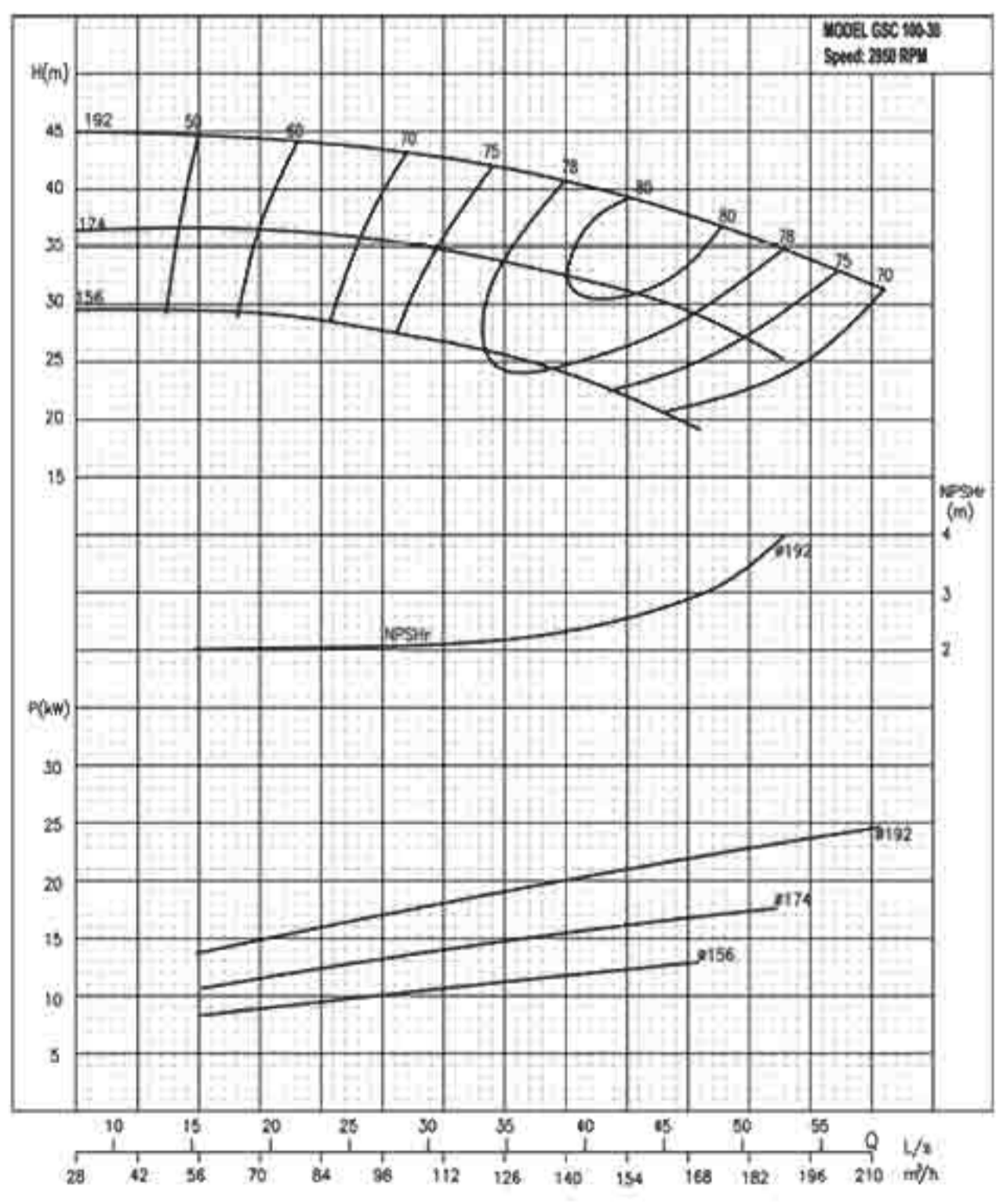
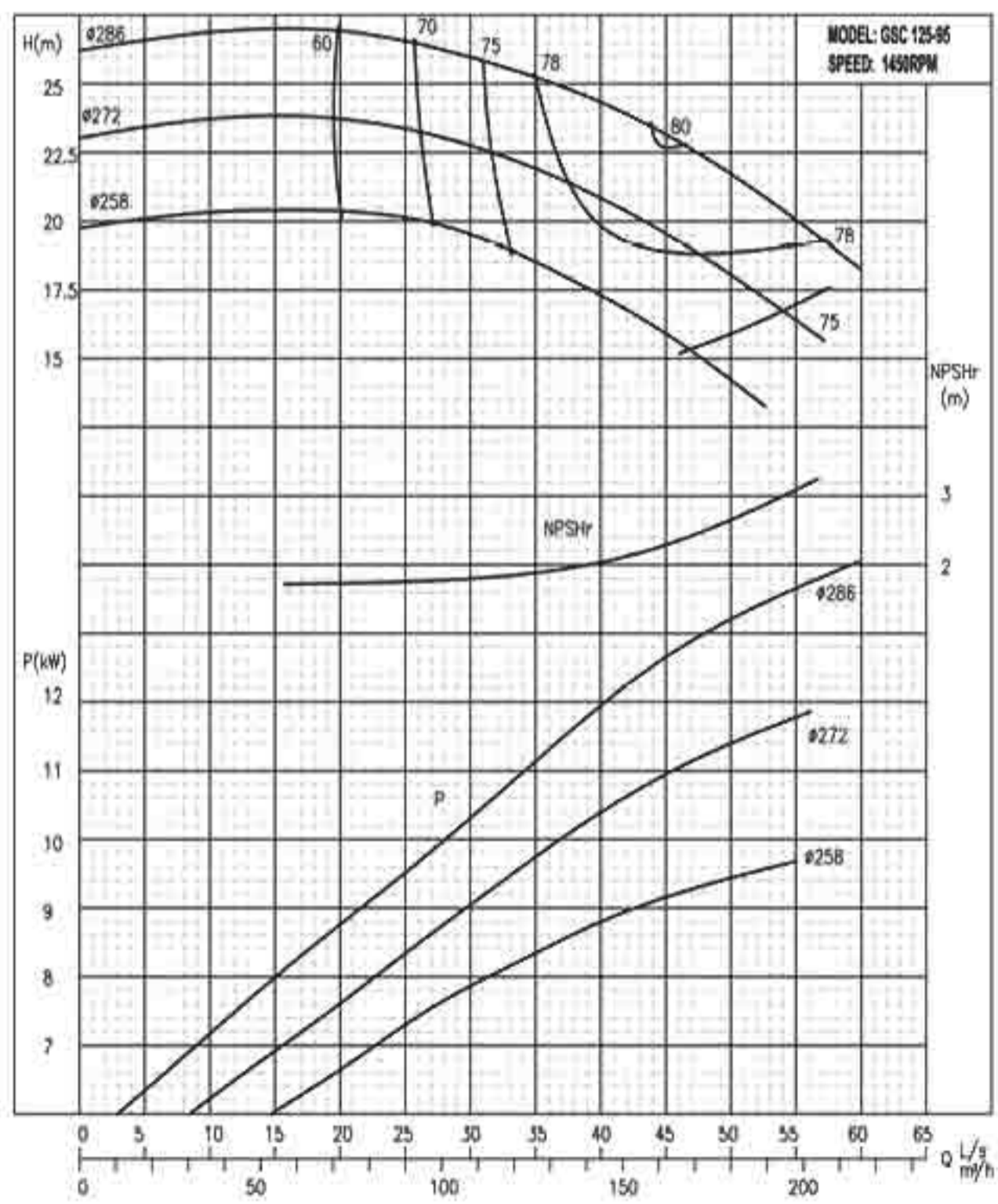
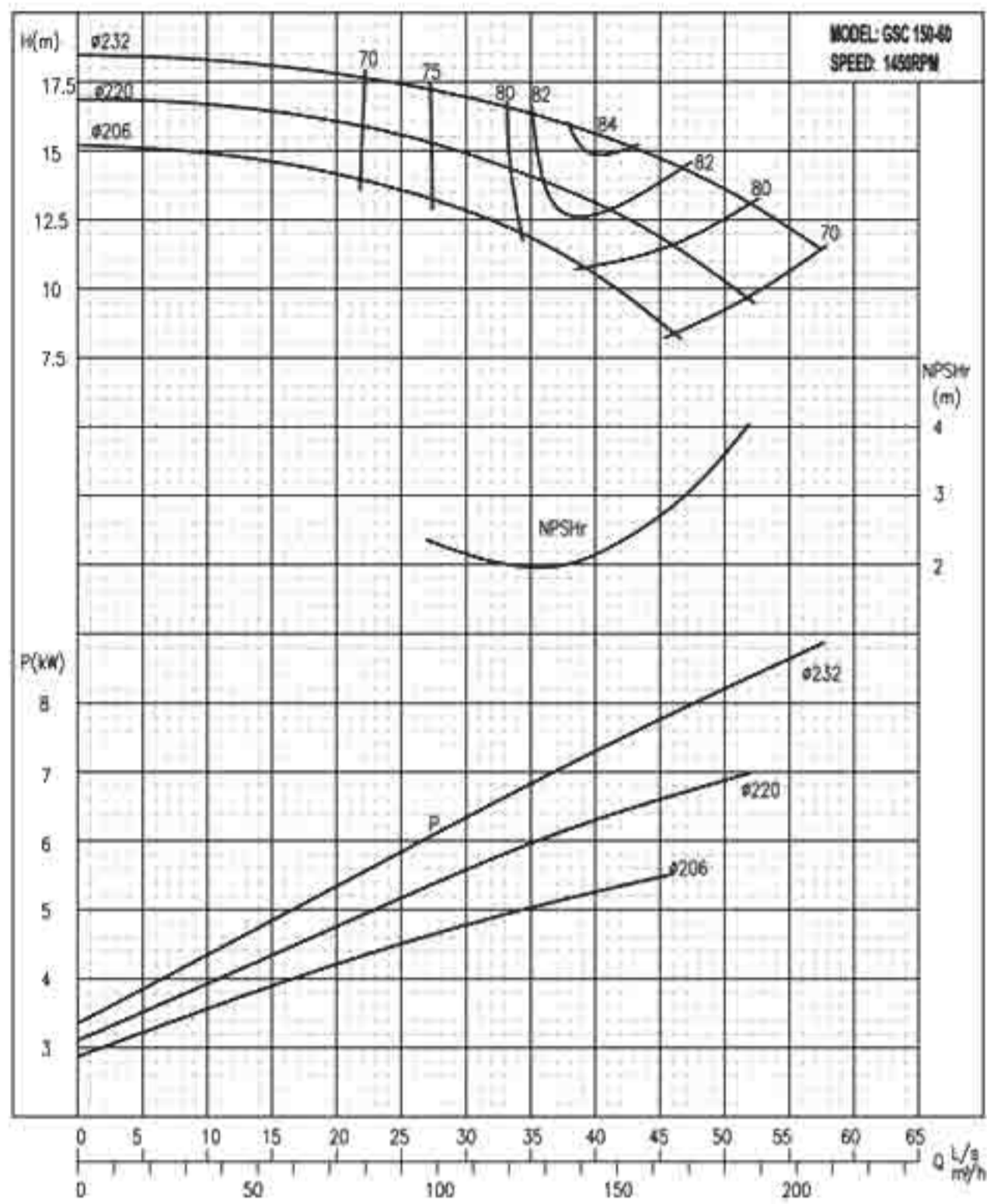
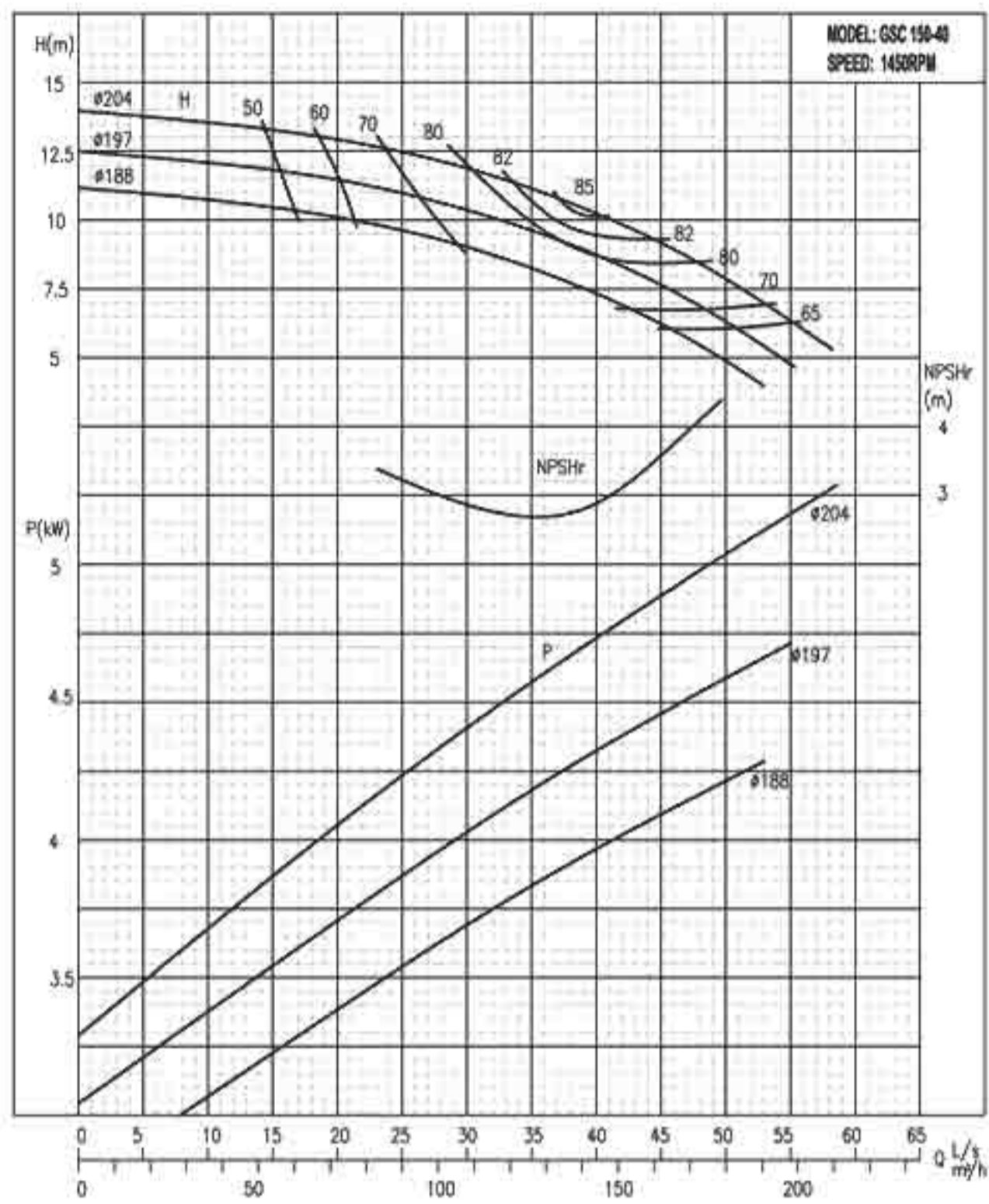

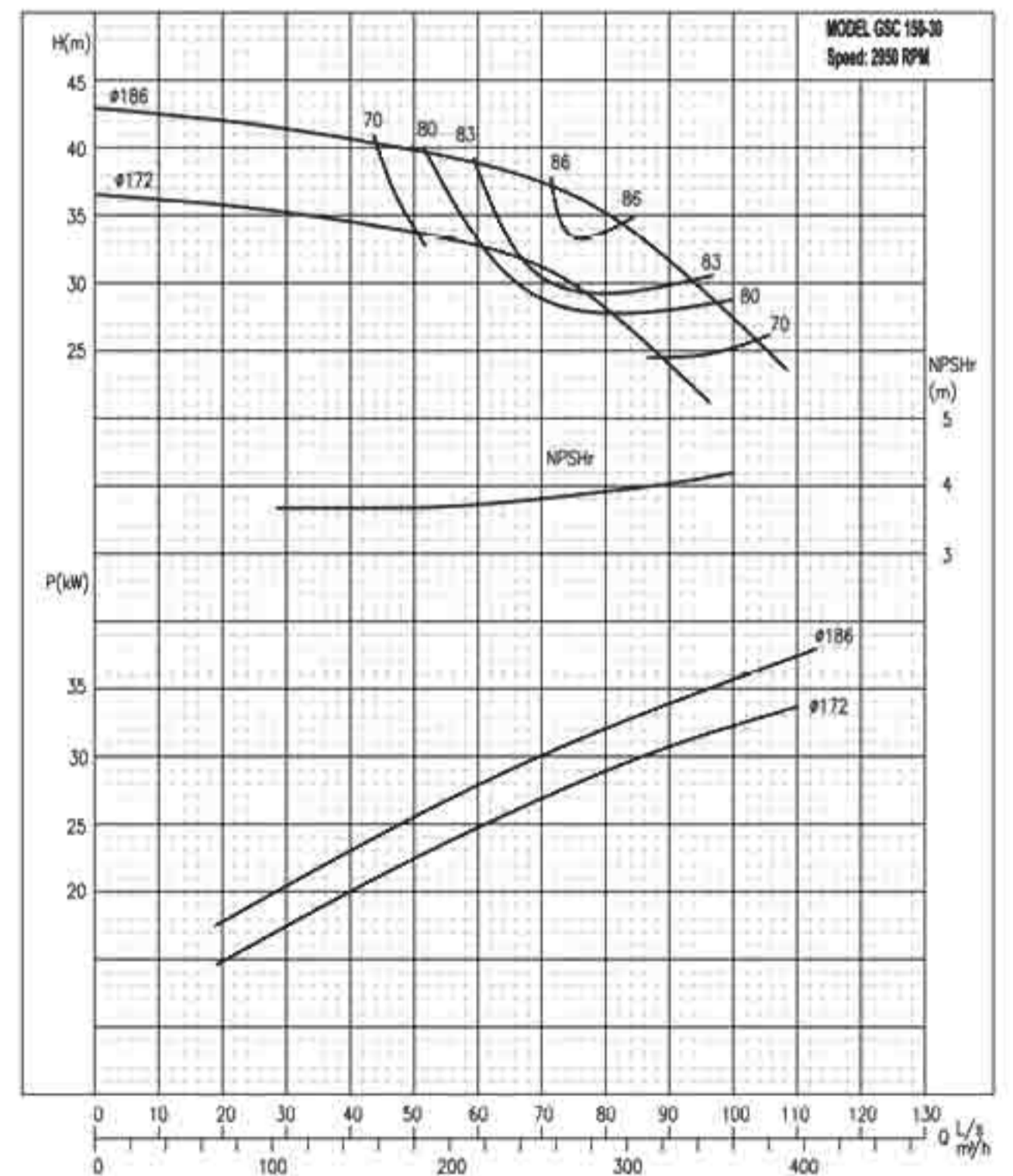
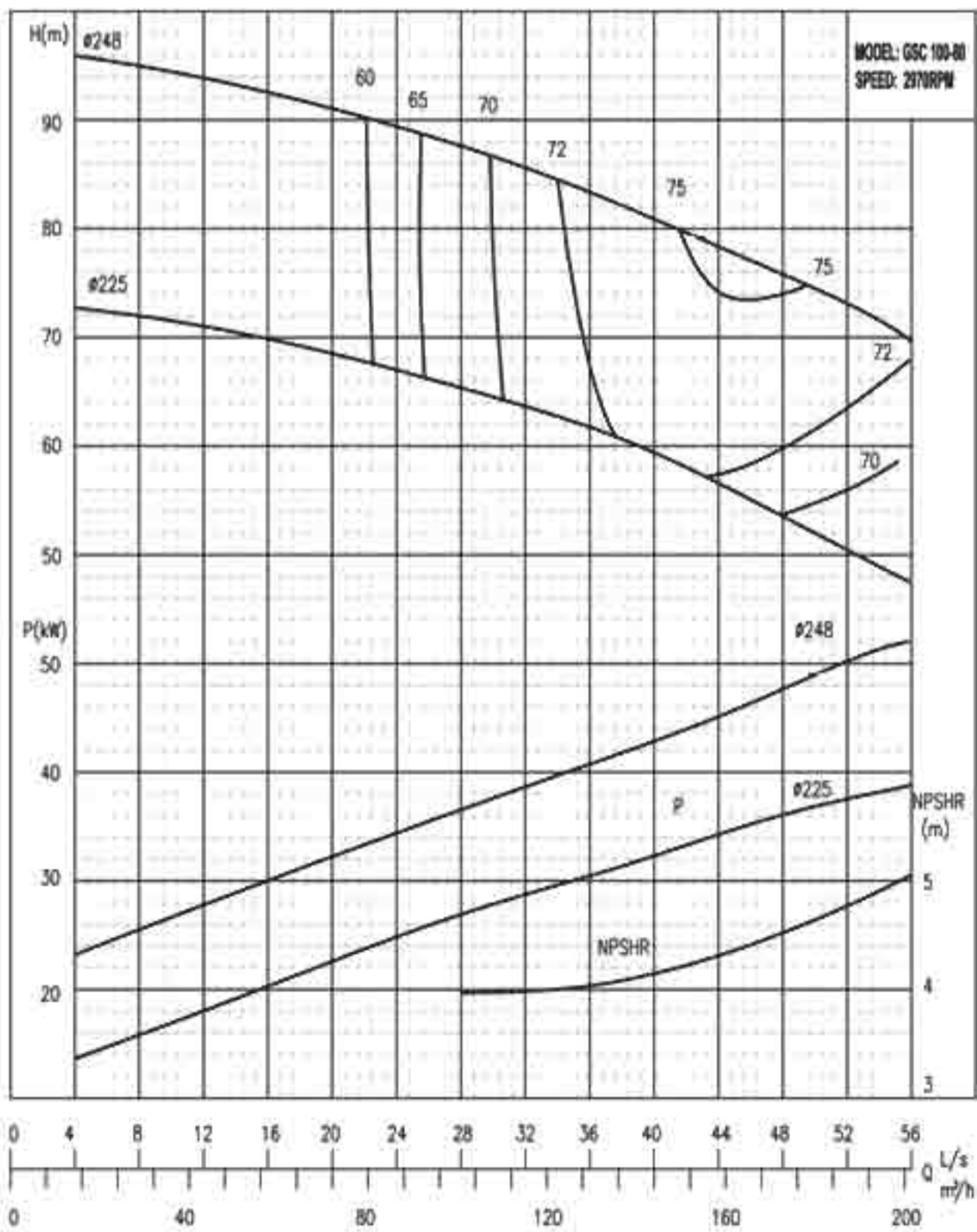
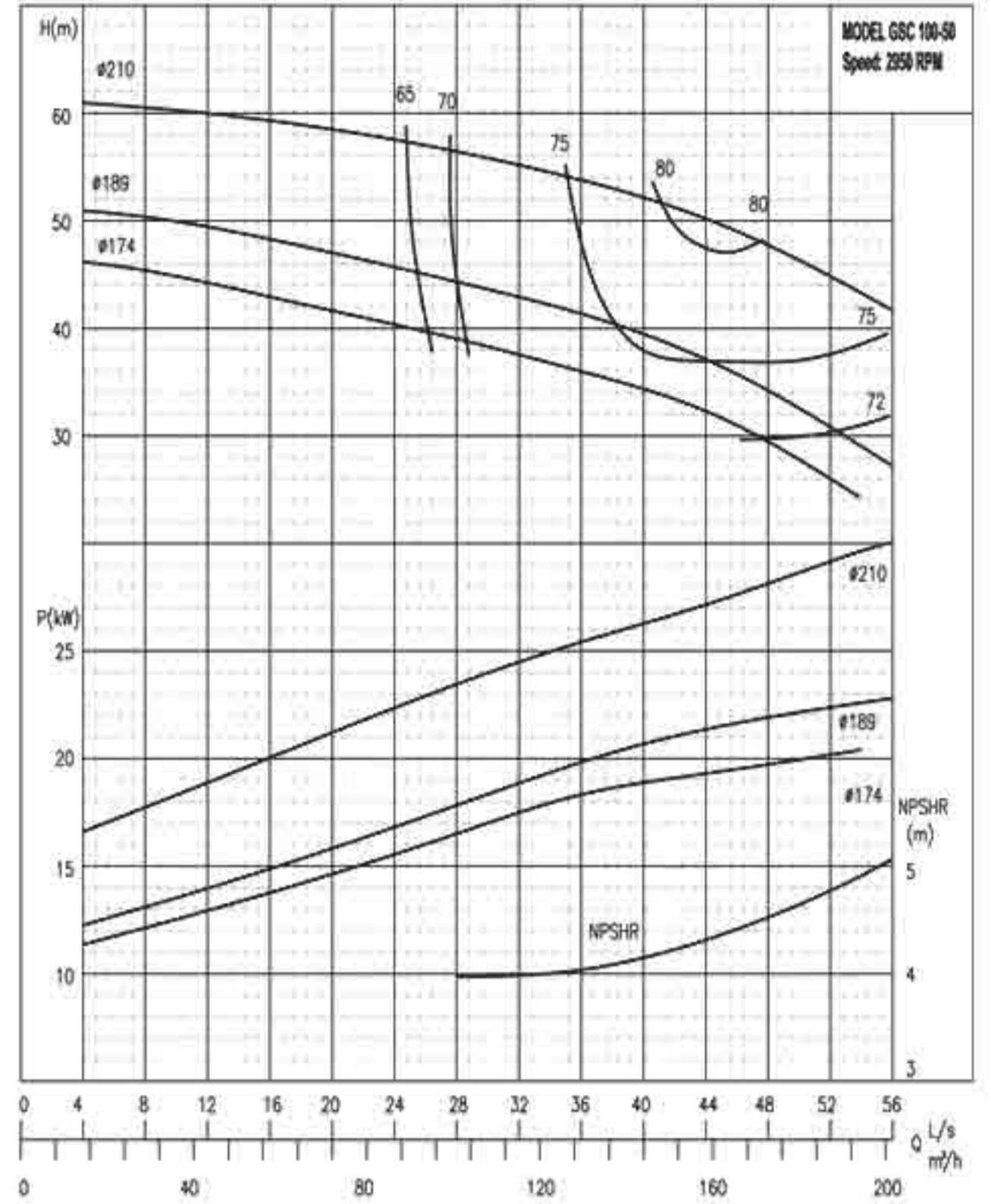
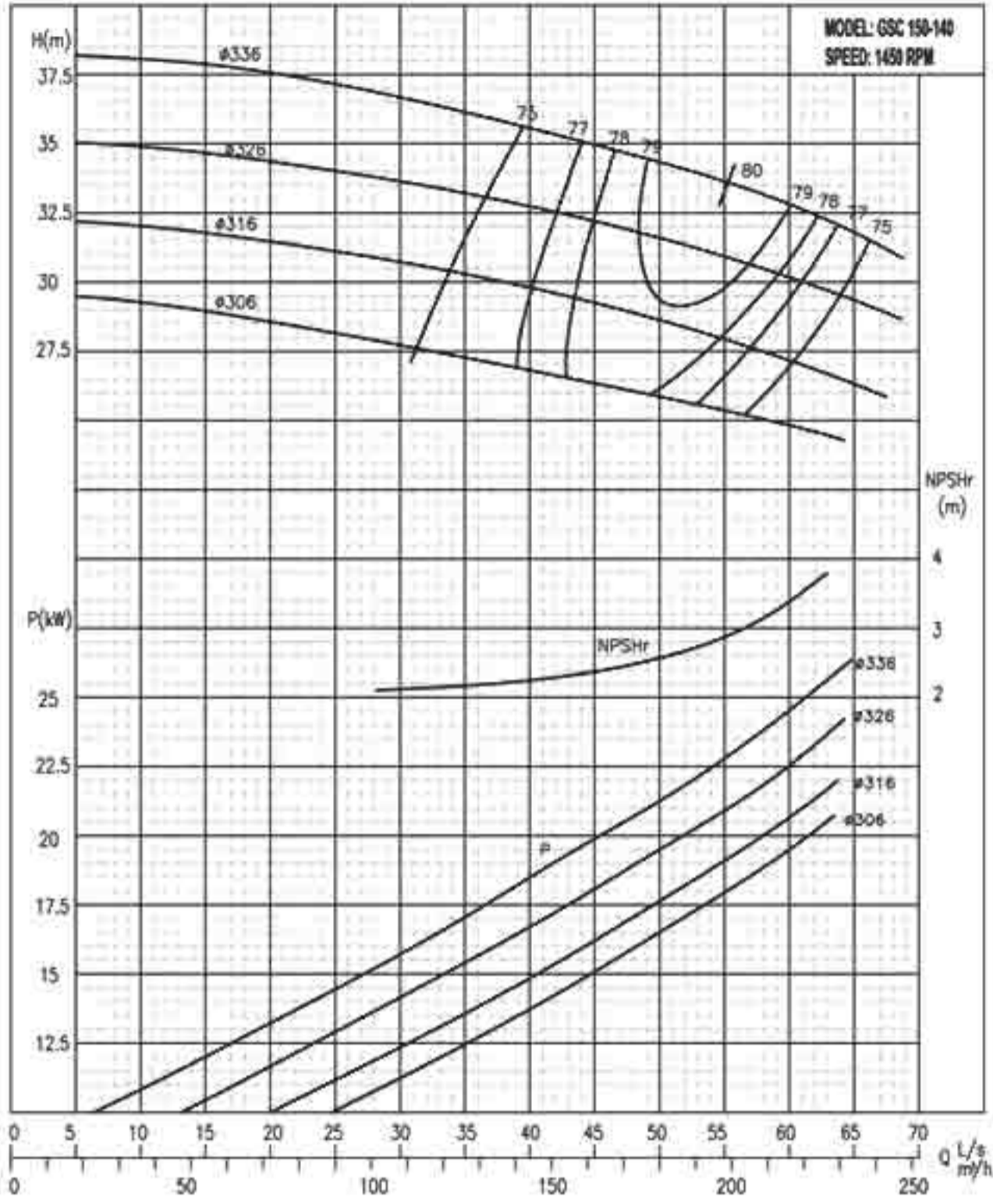



Performance Curves

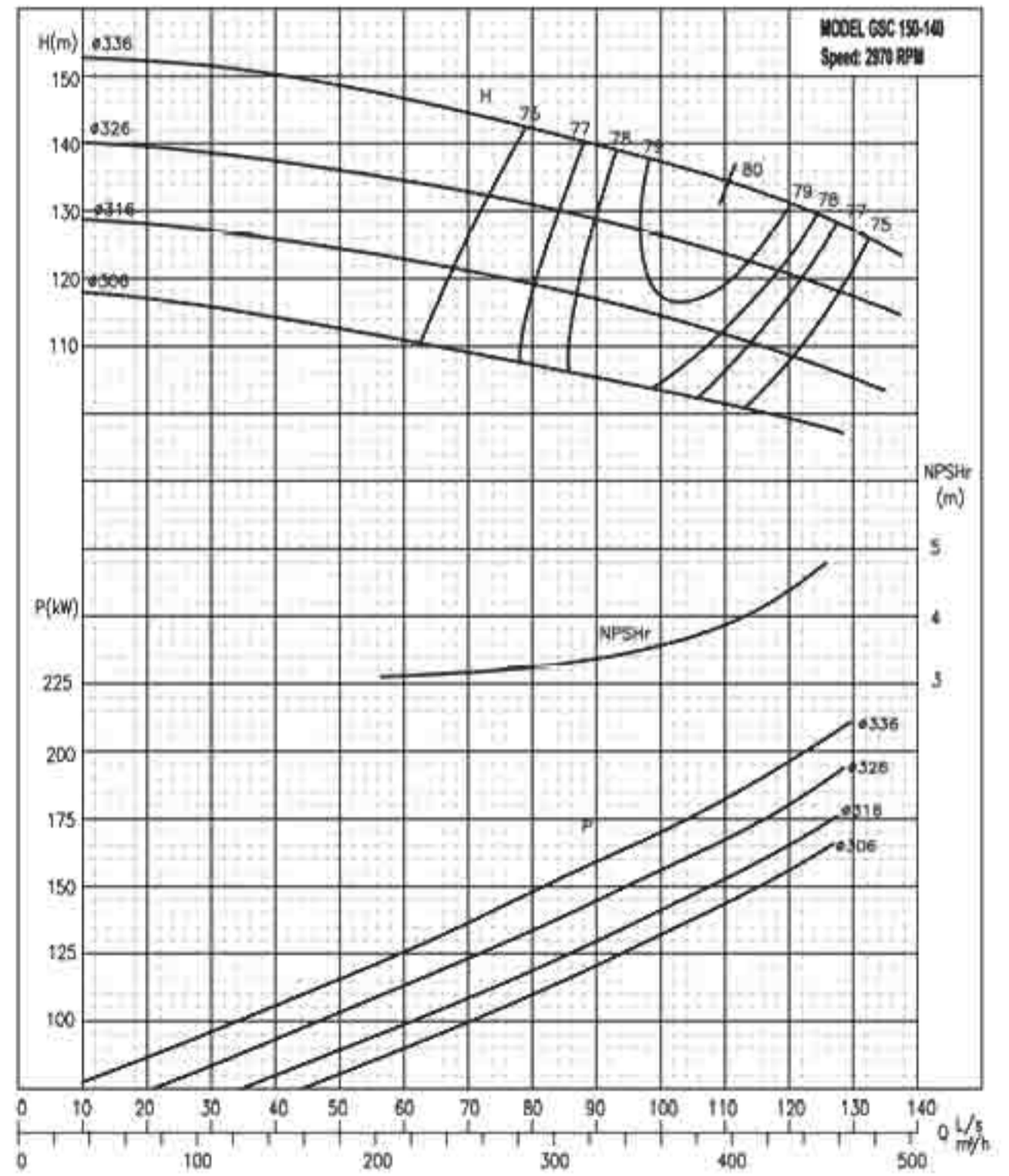
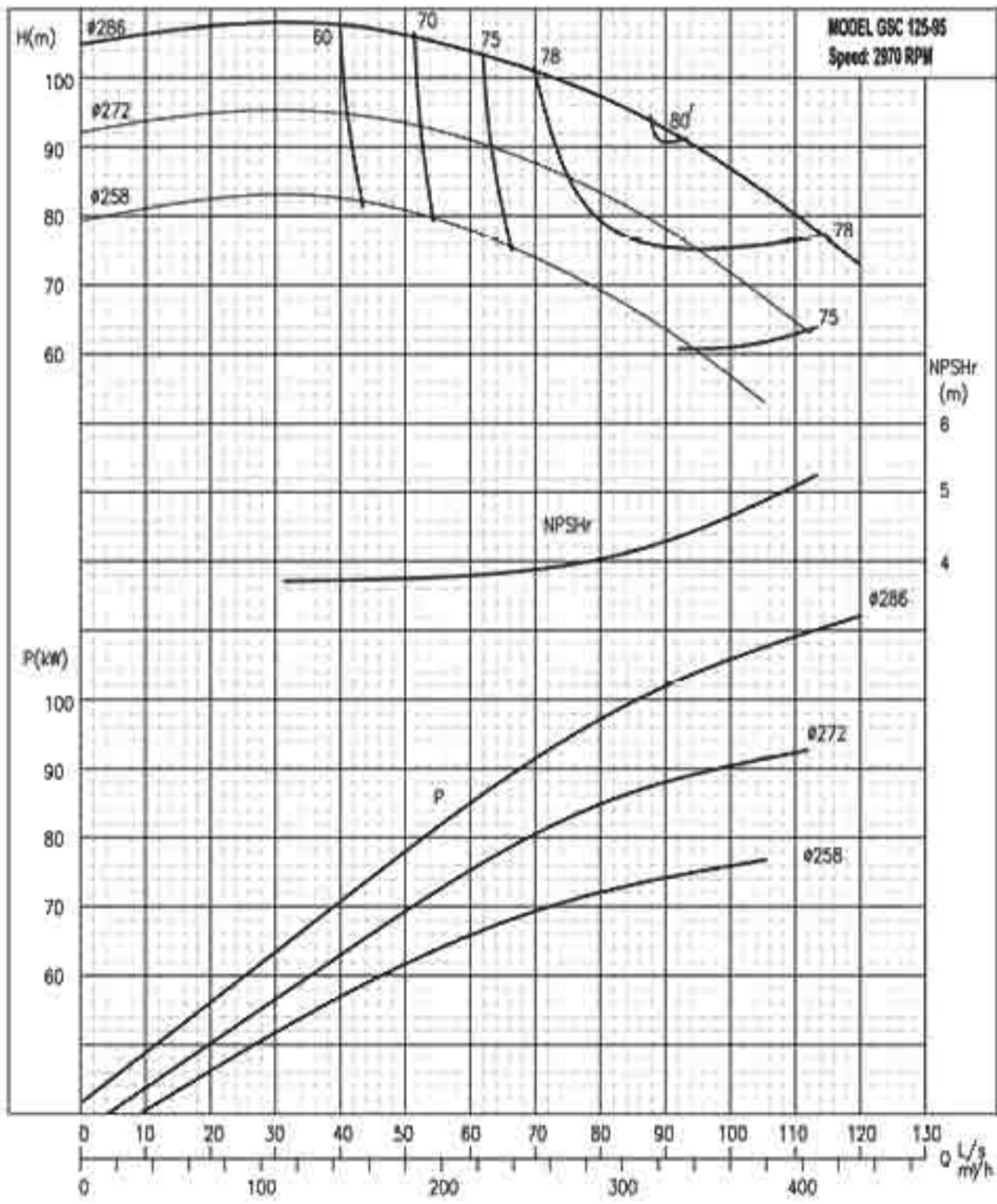
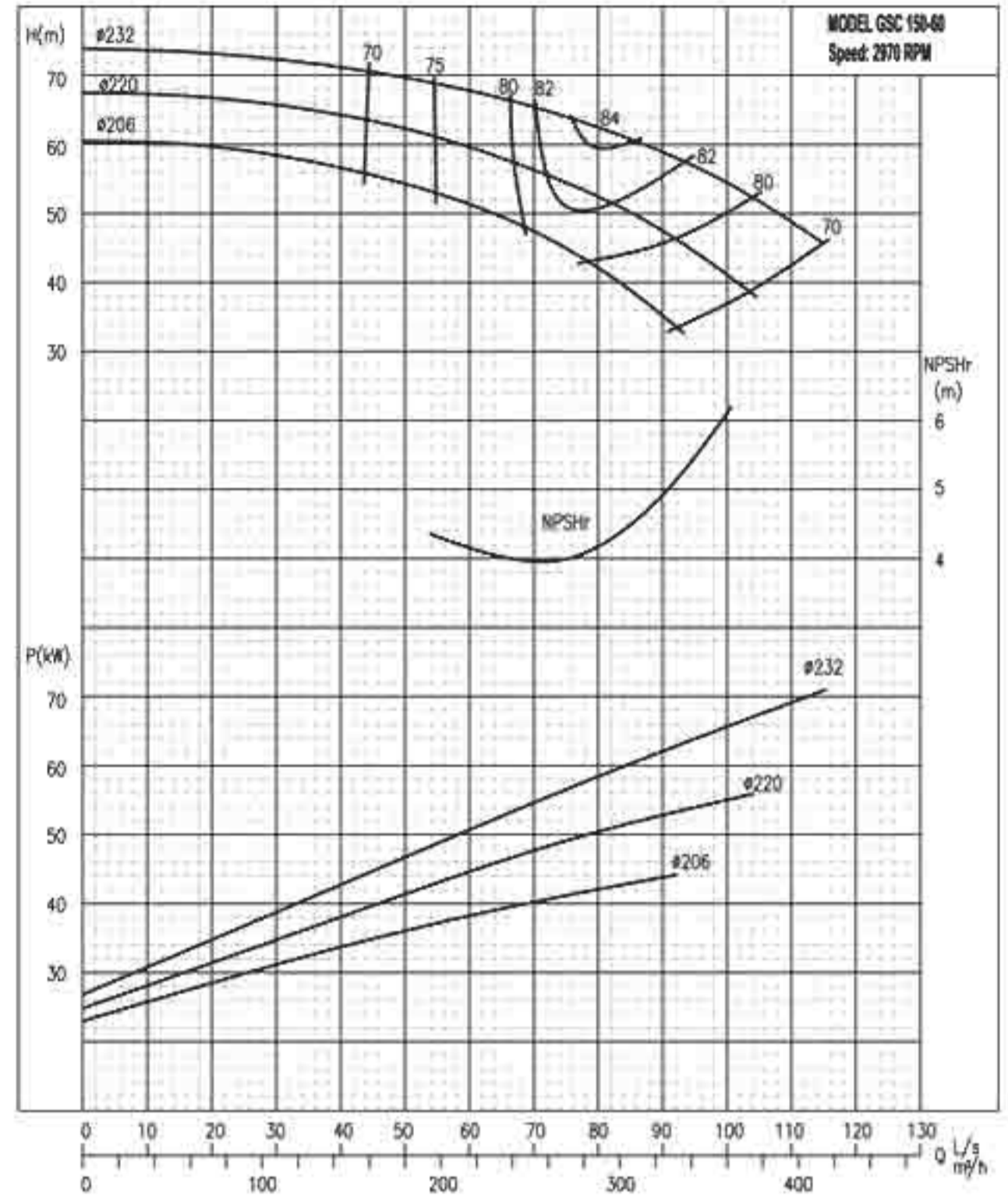
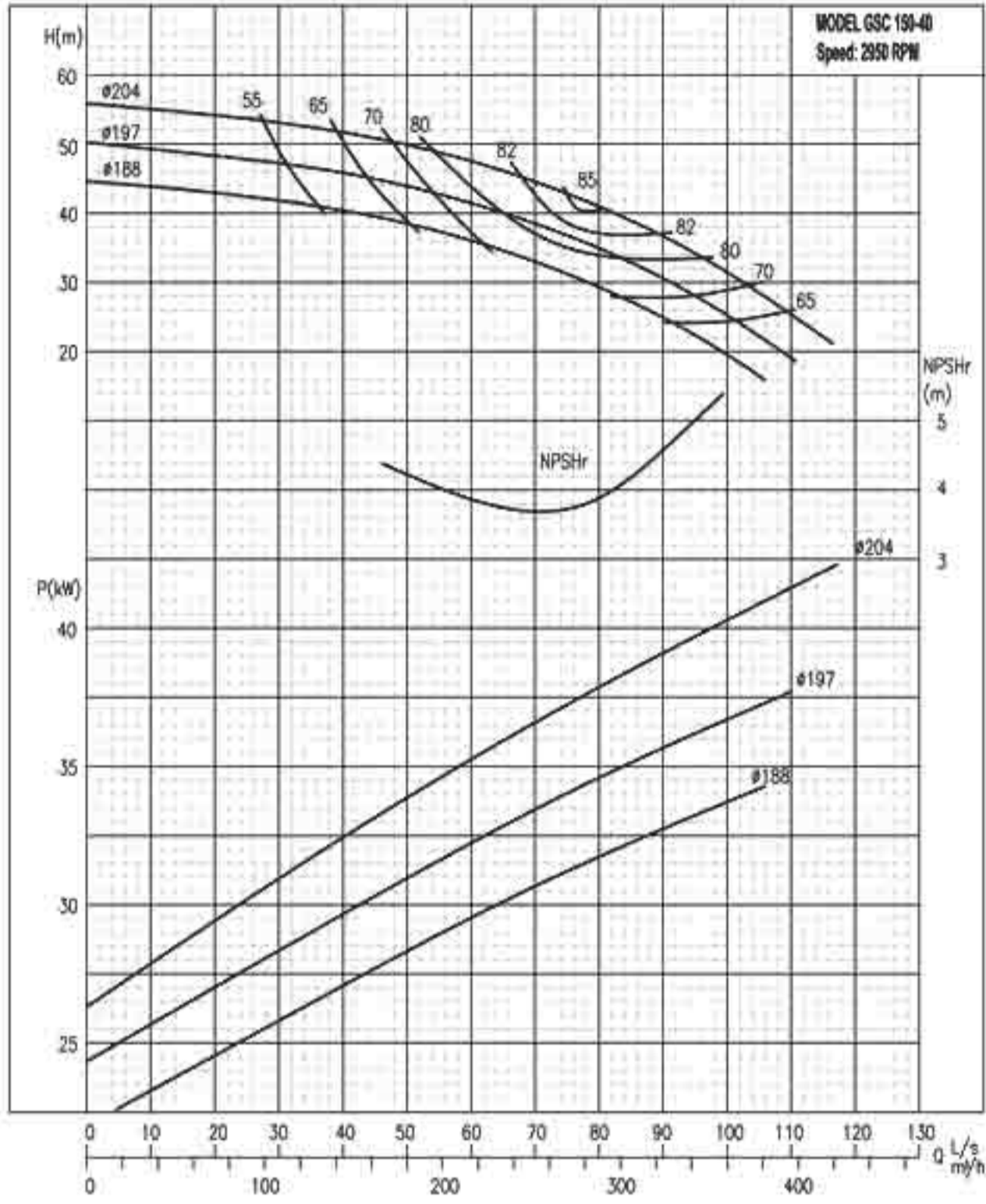

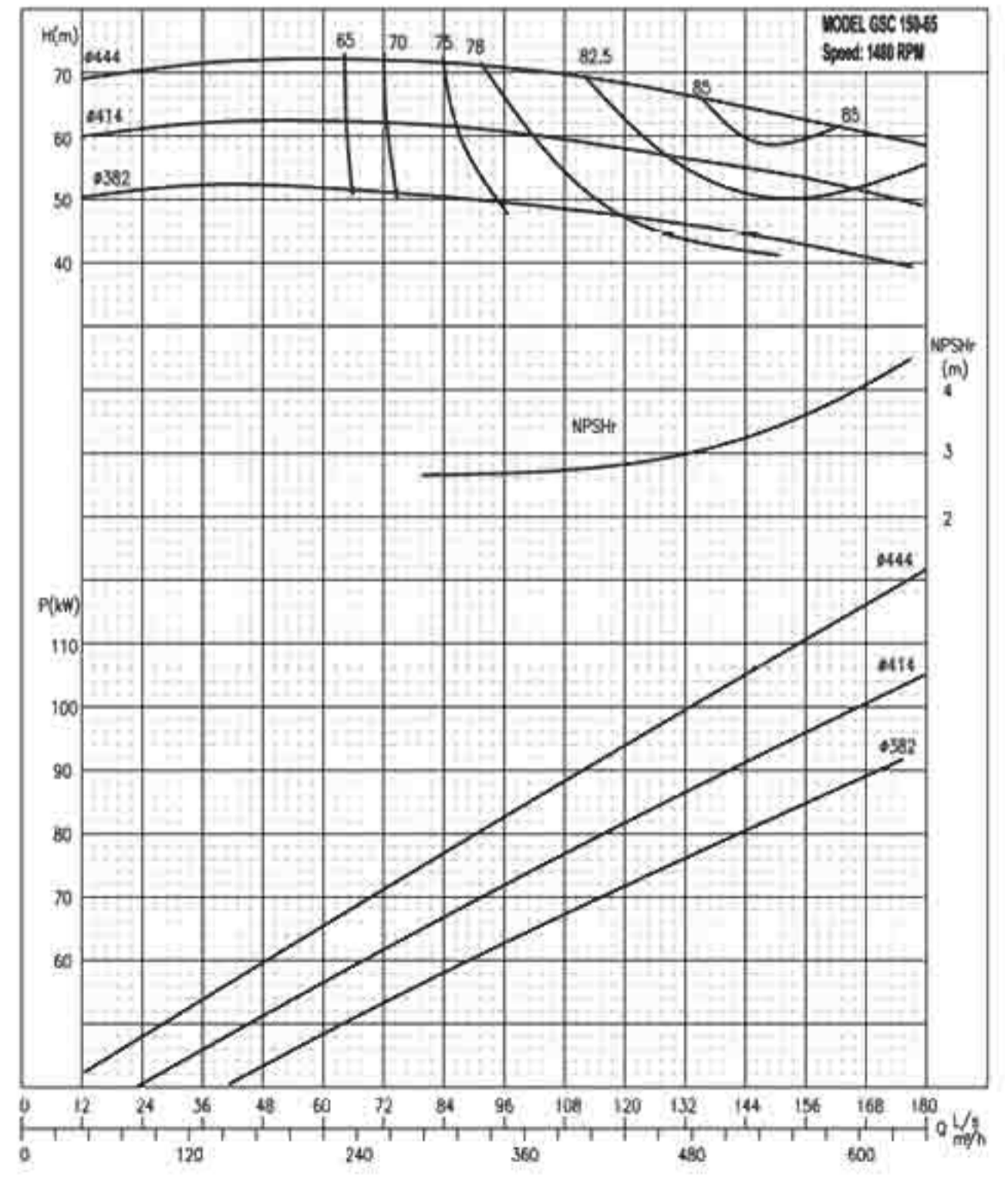
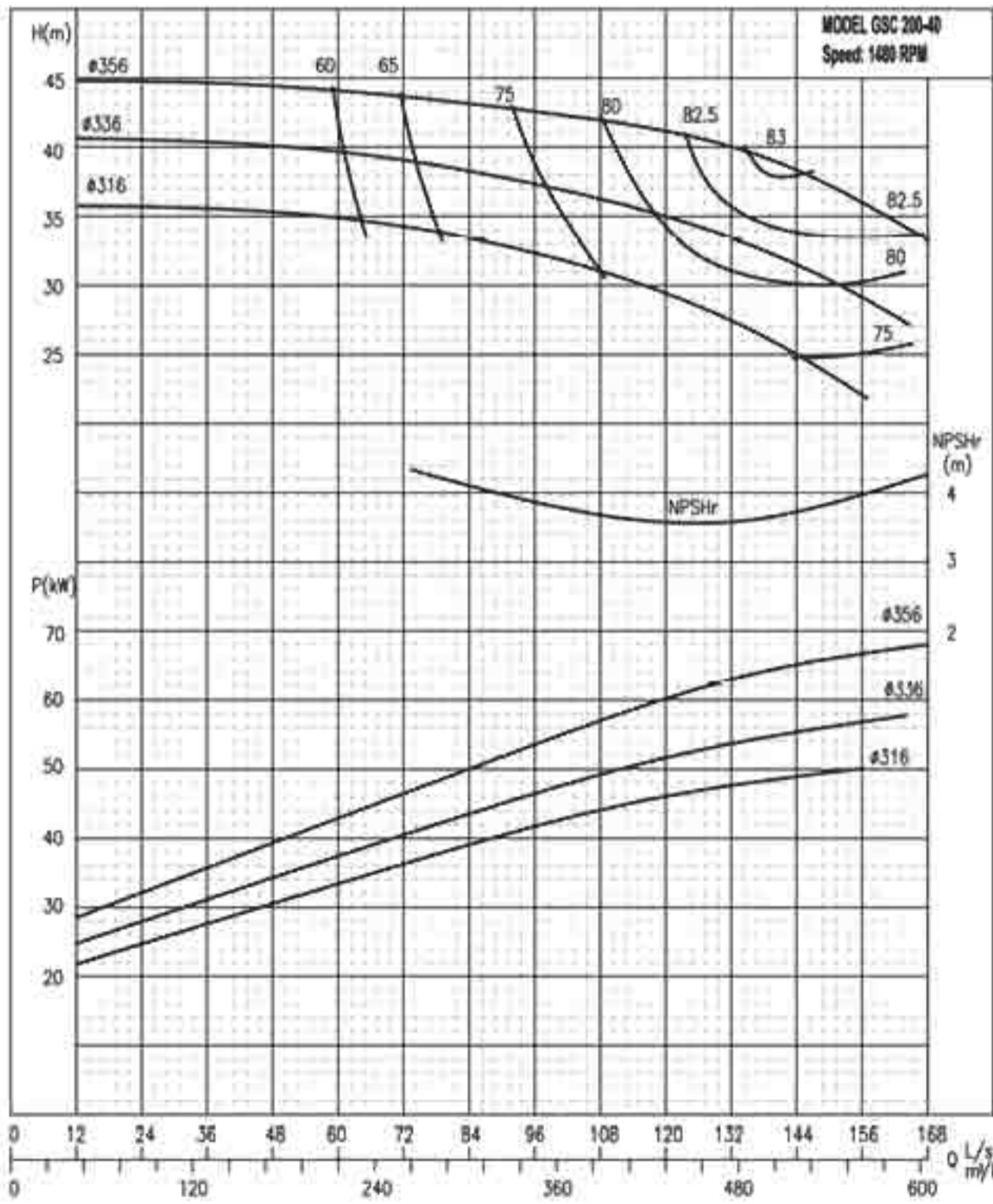
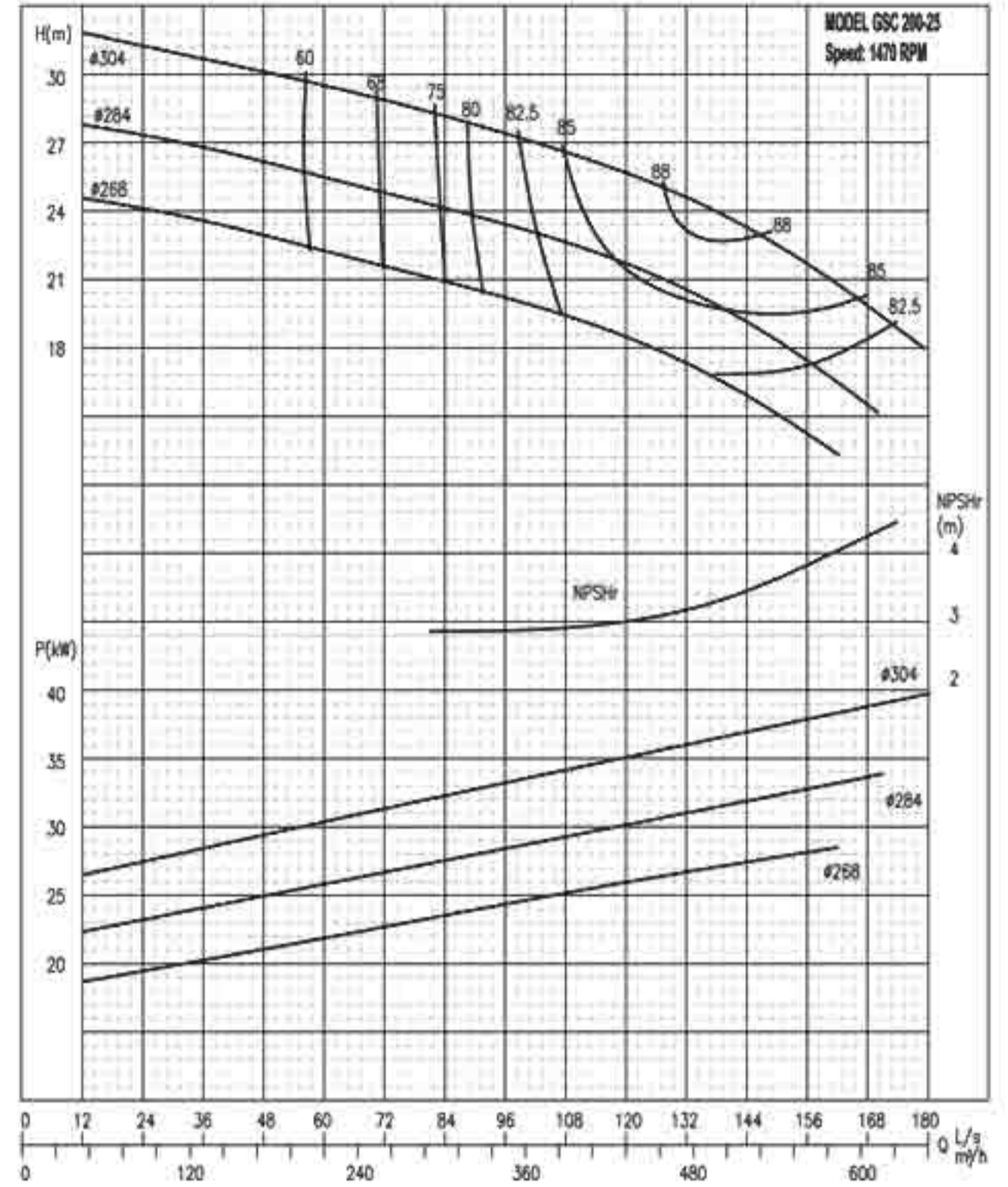
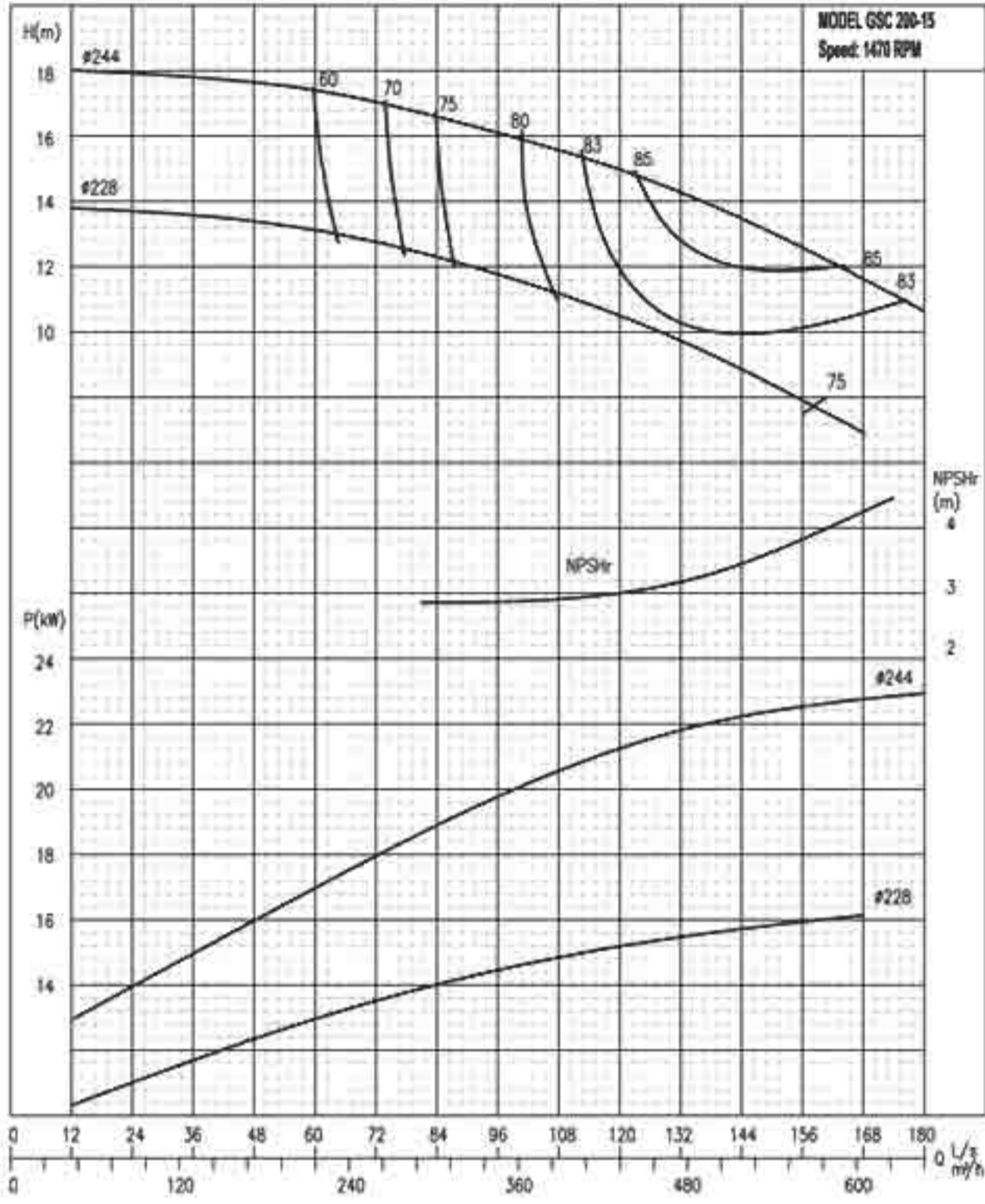



Performance Curves

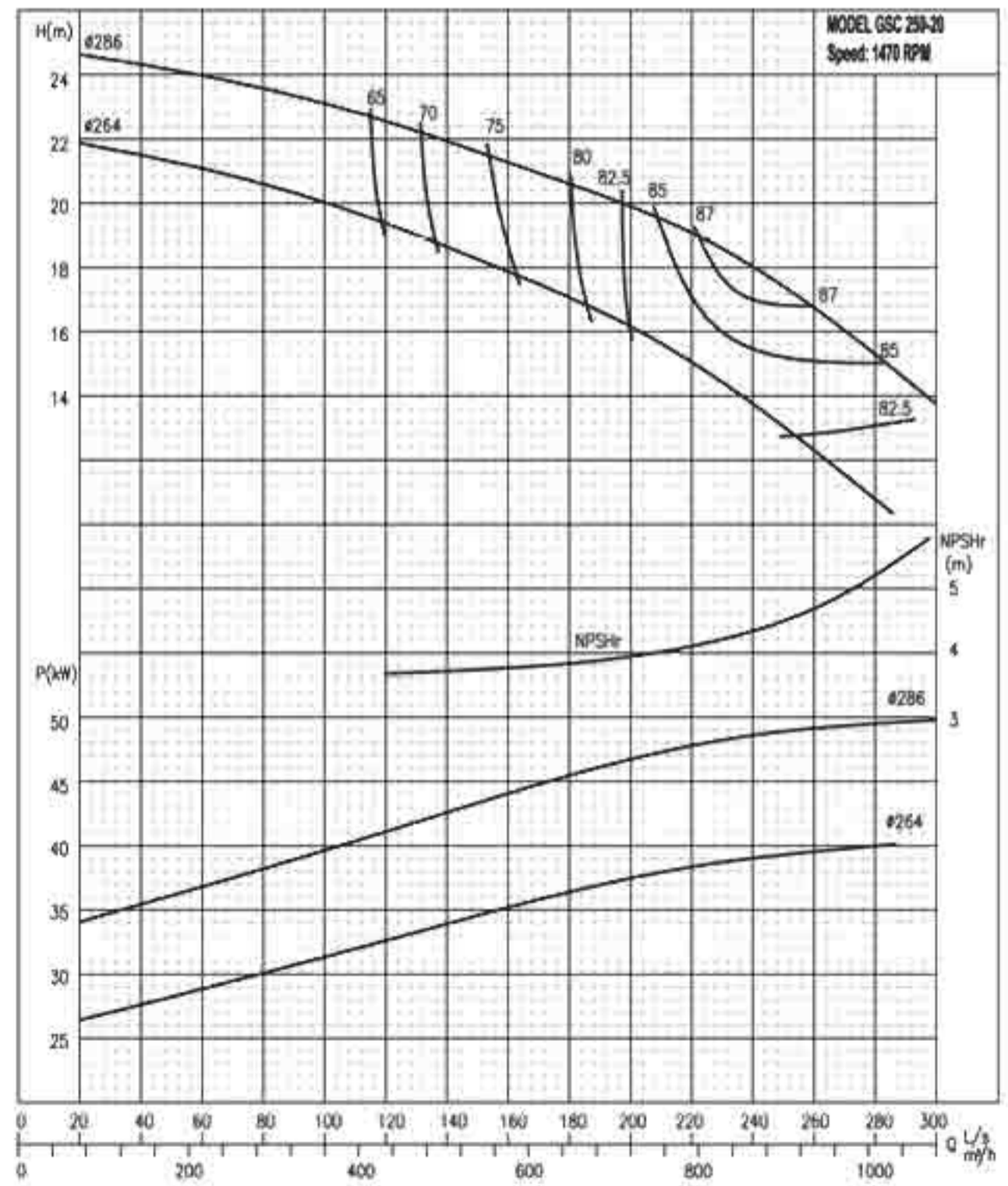
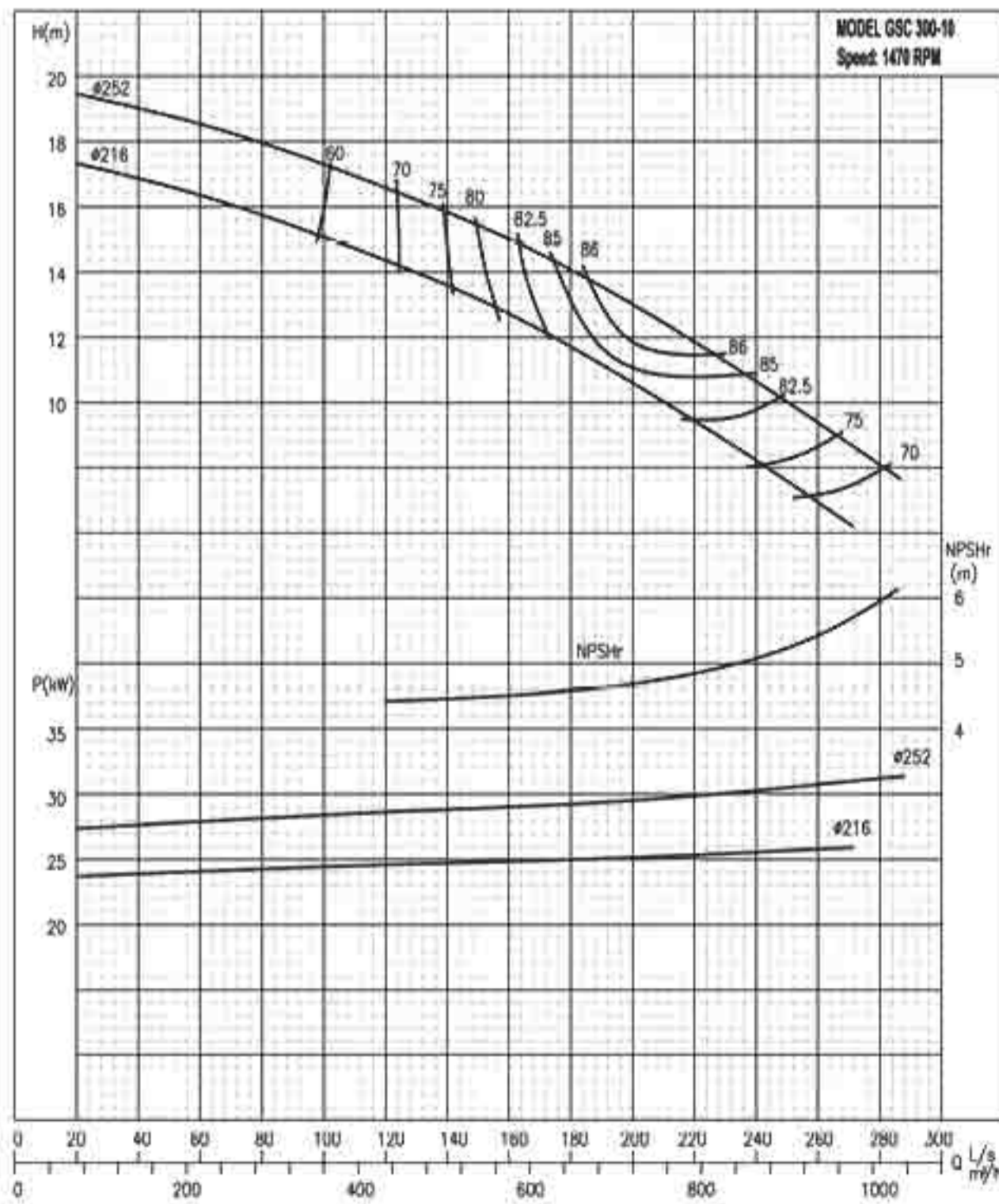
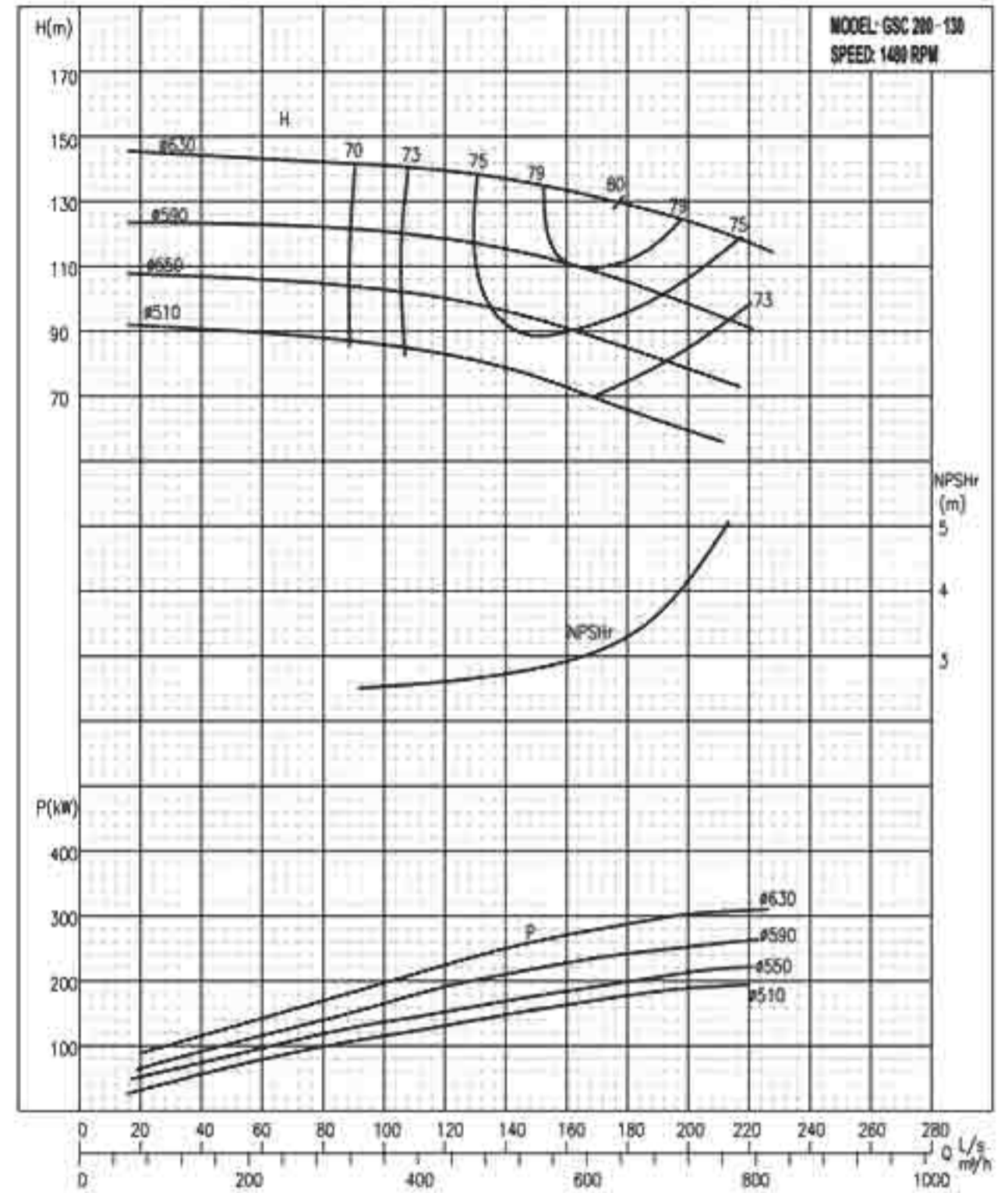
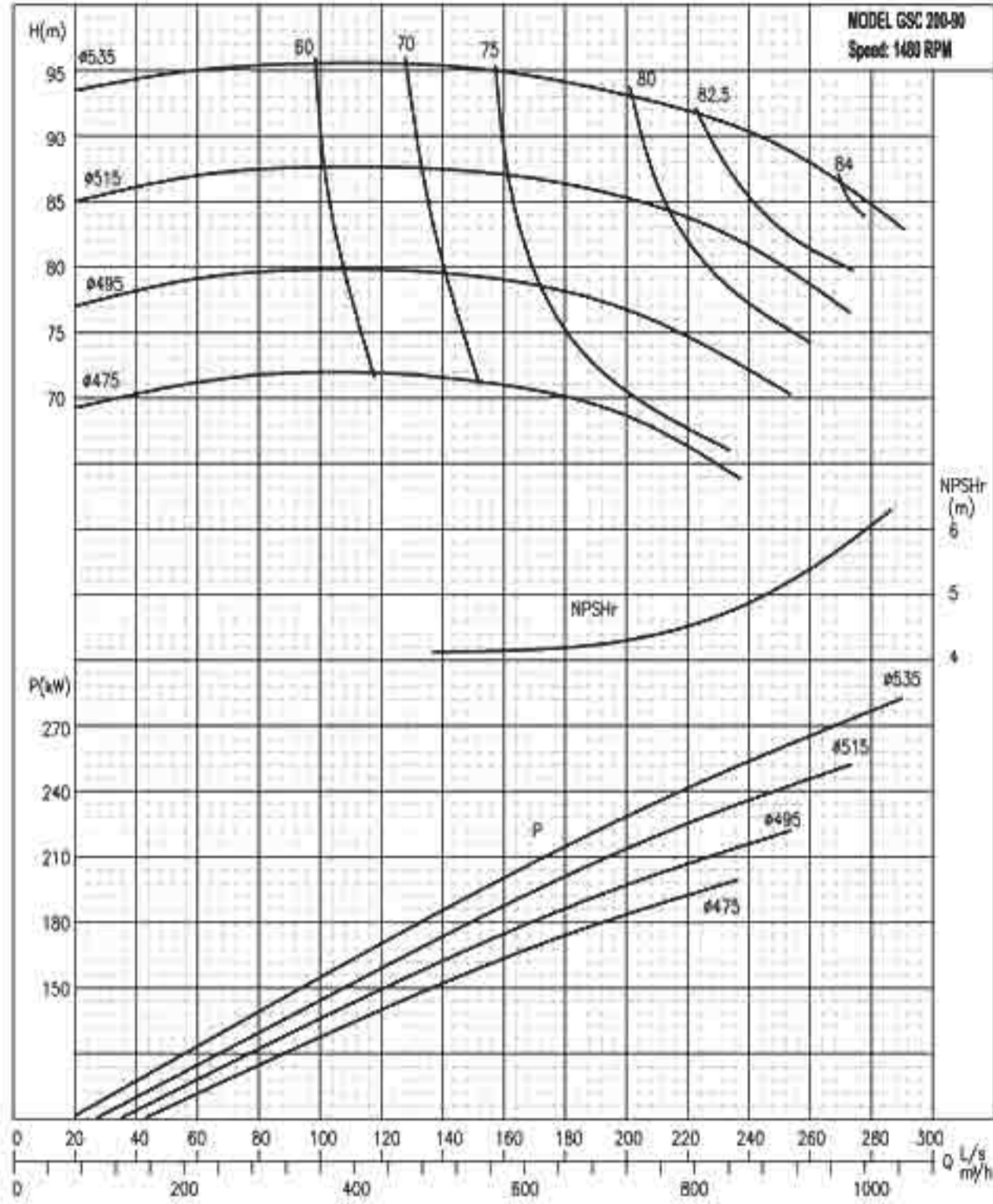

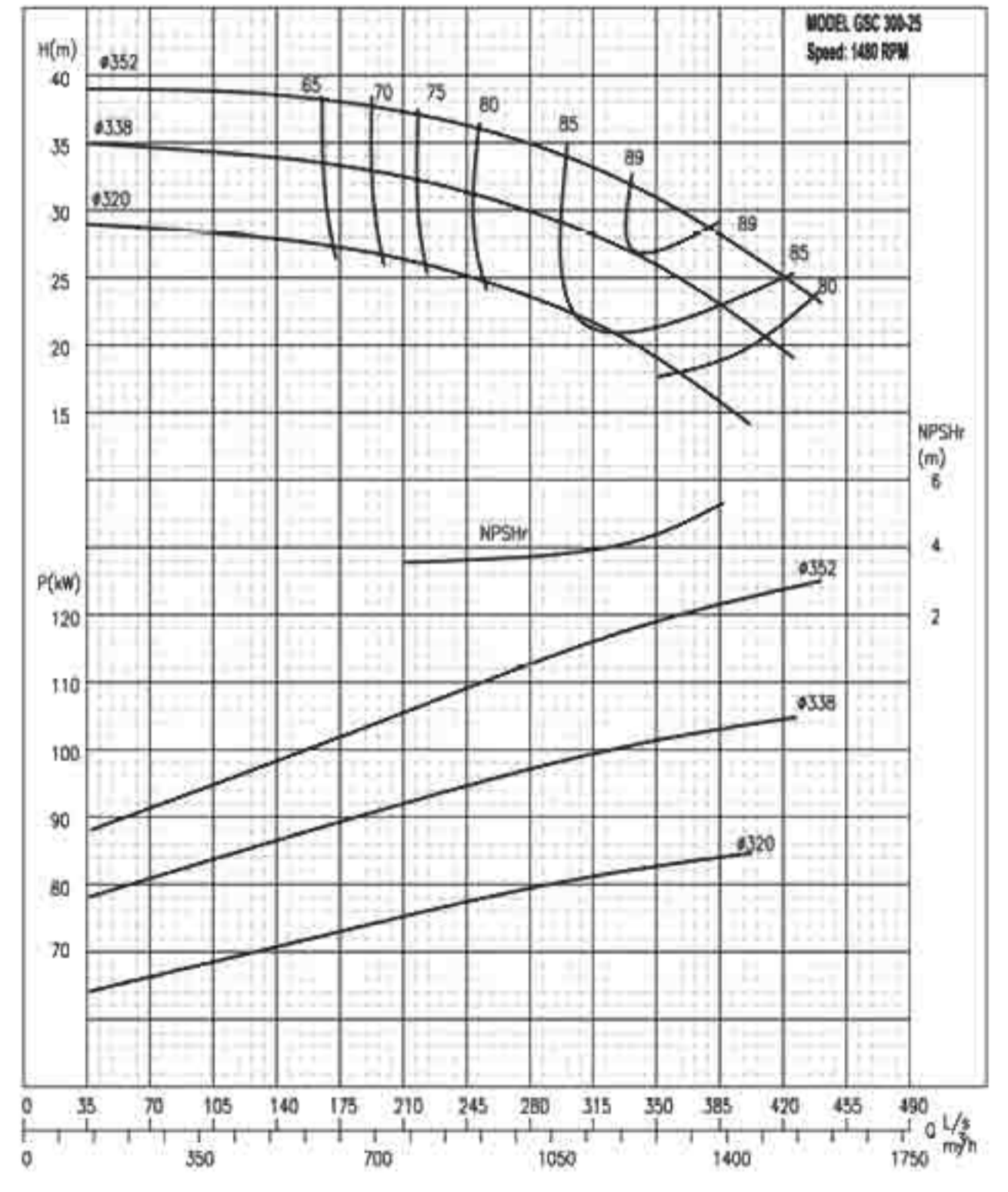
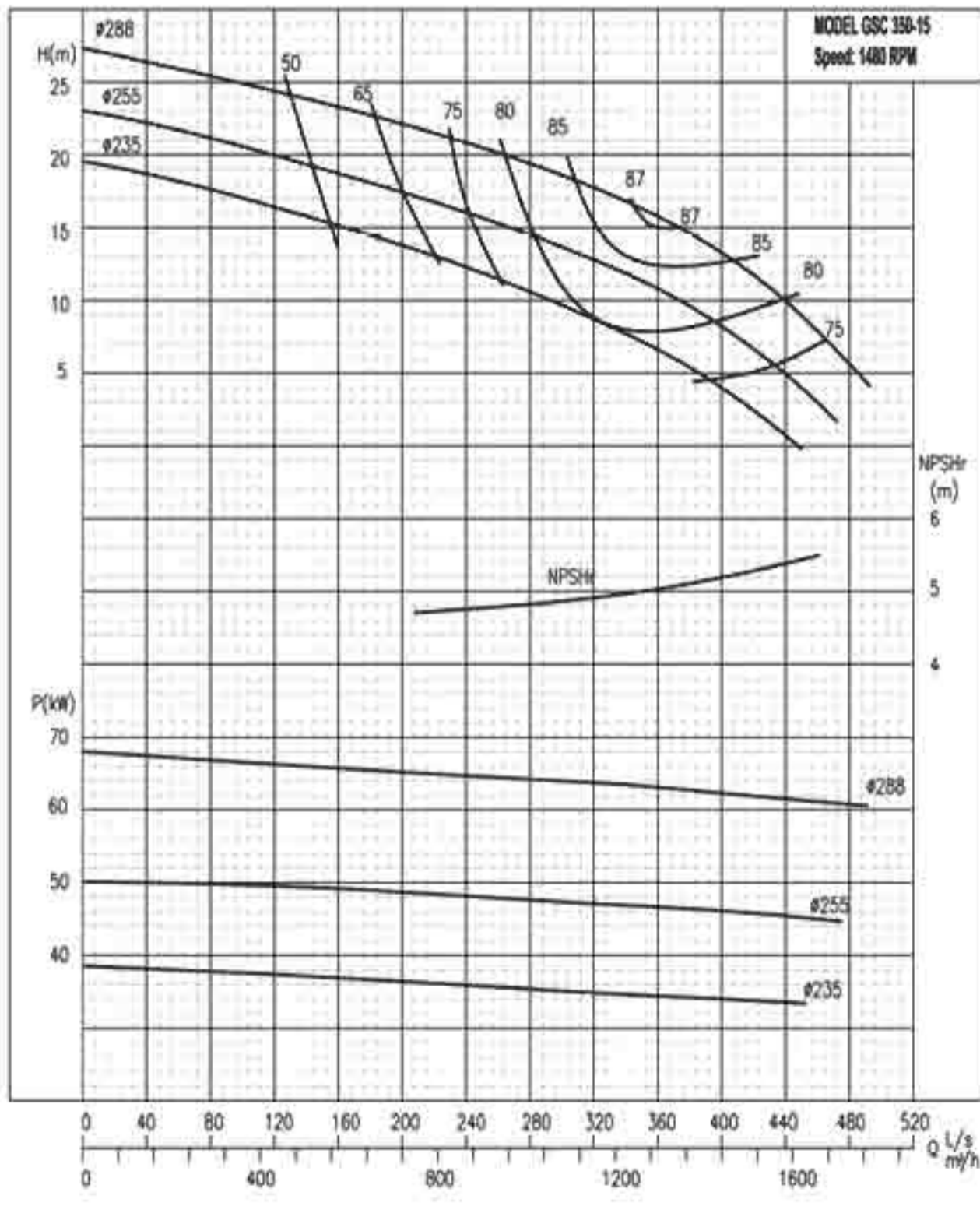
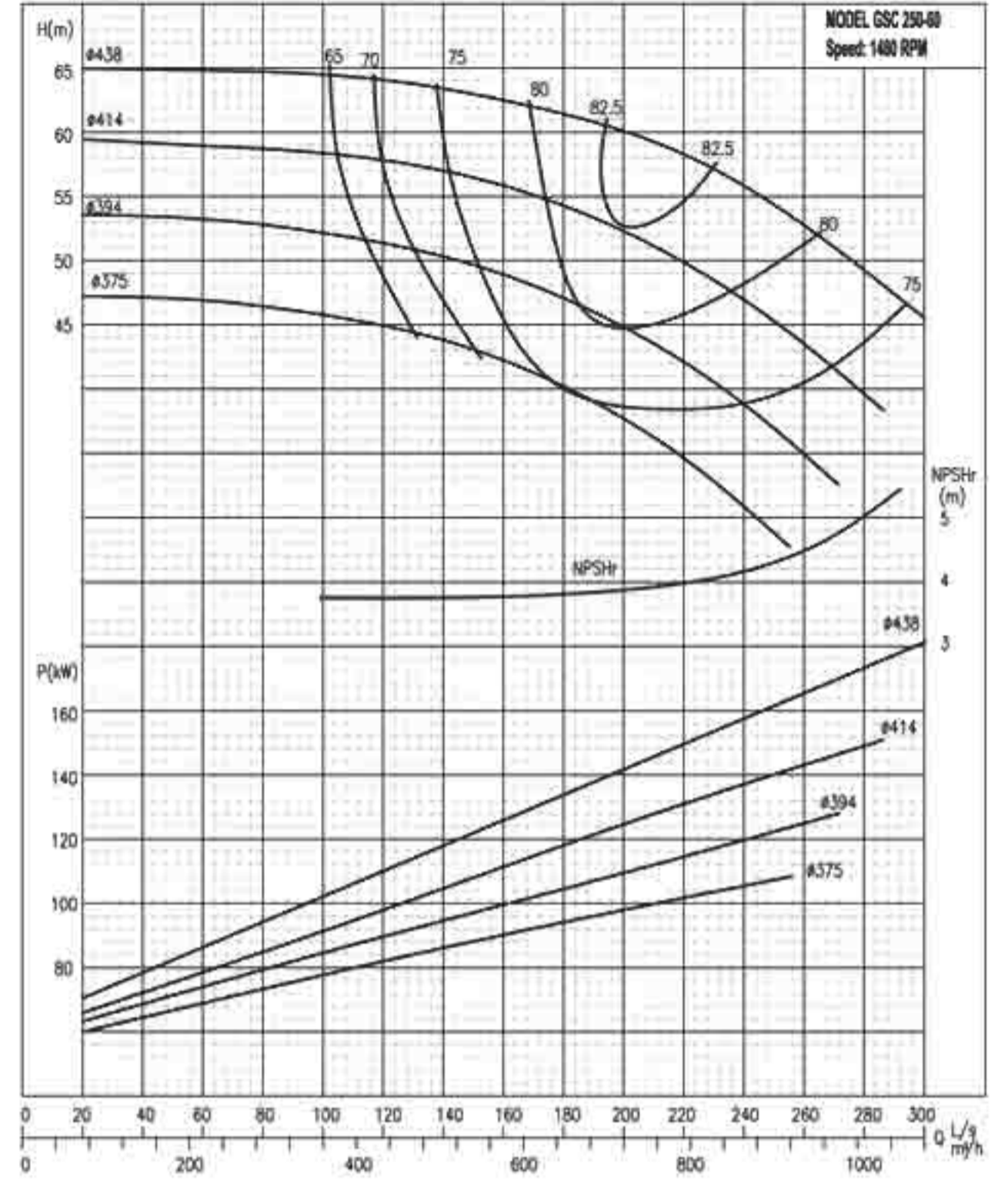
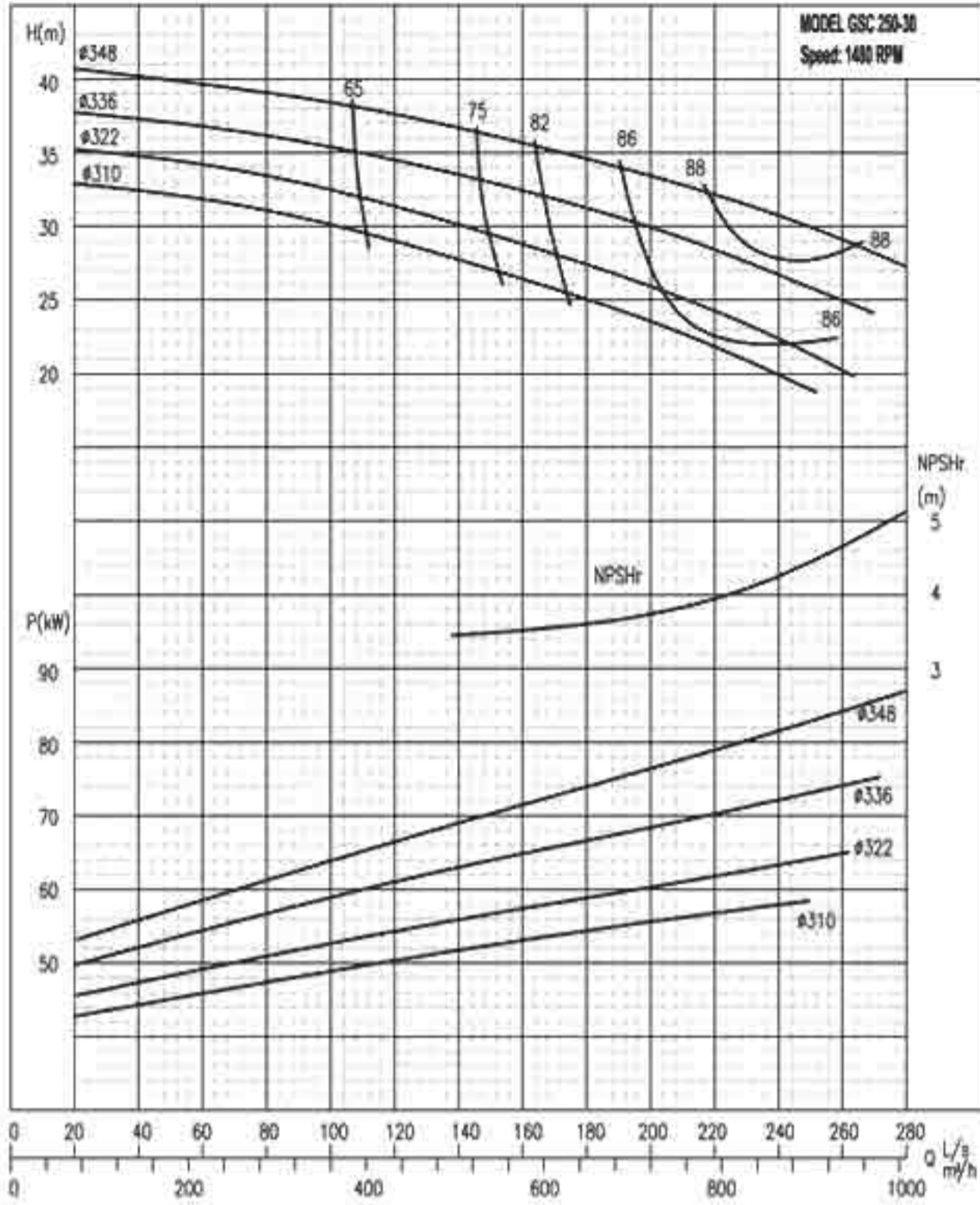



Performance Curves

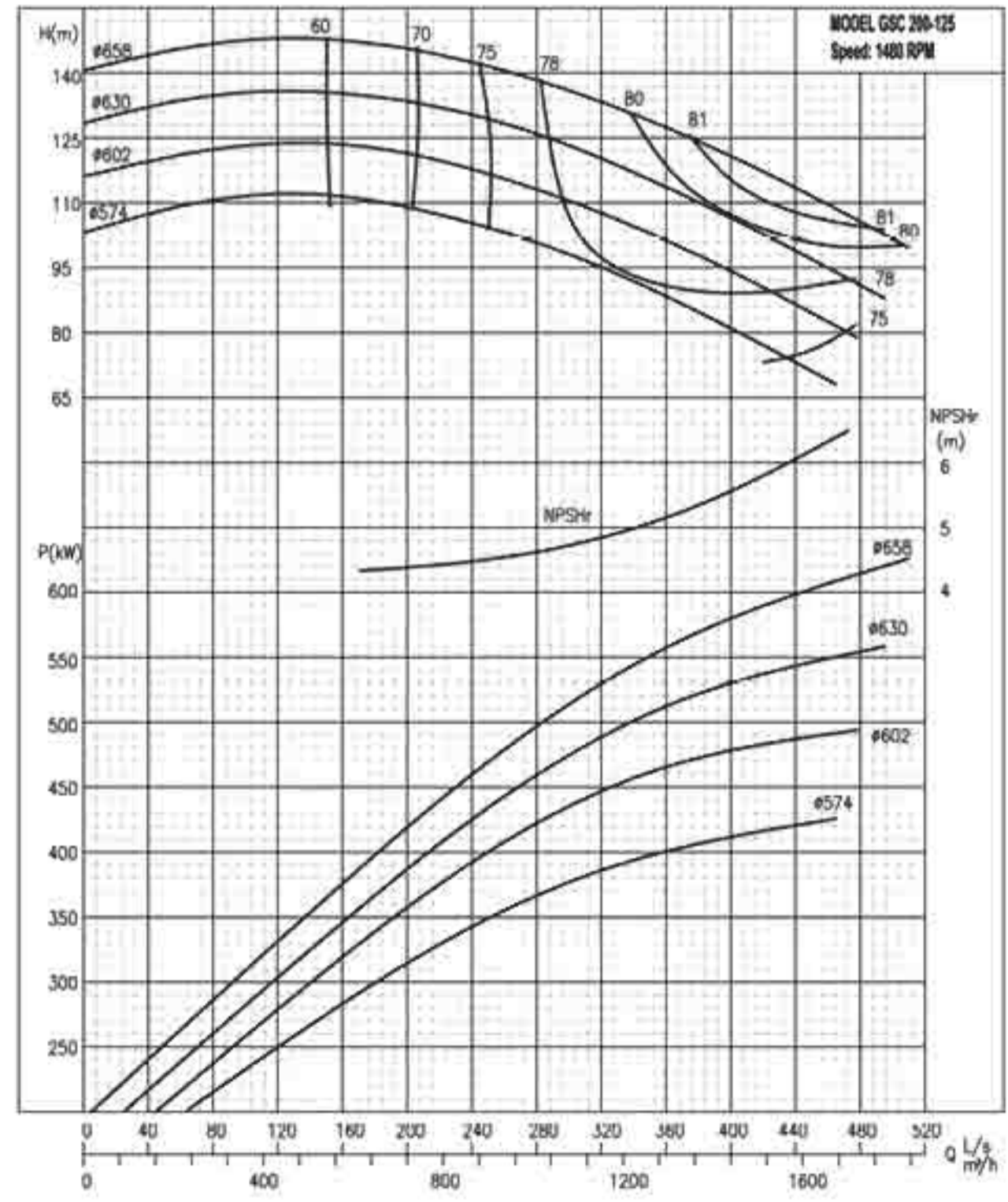
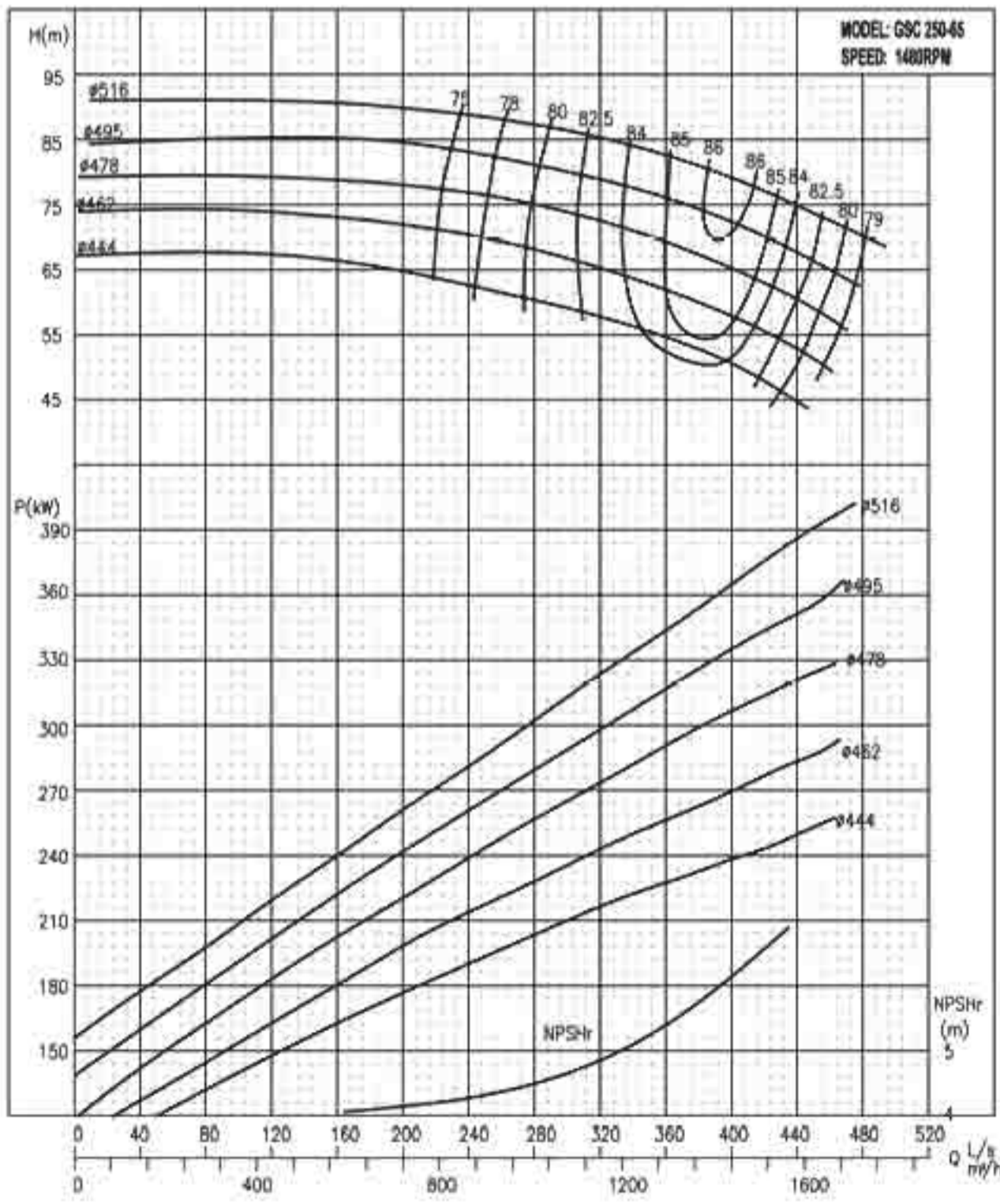
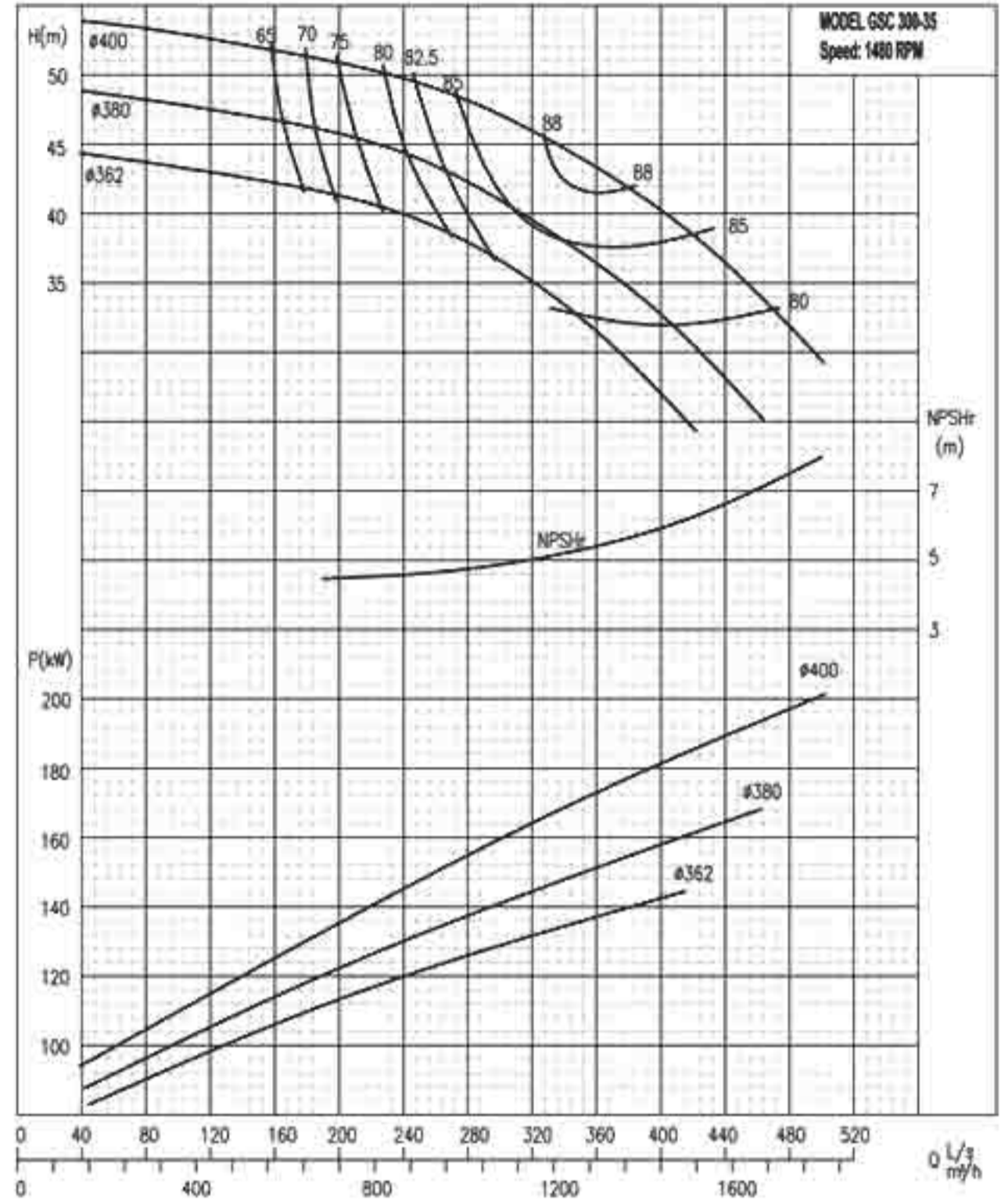
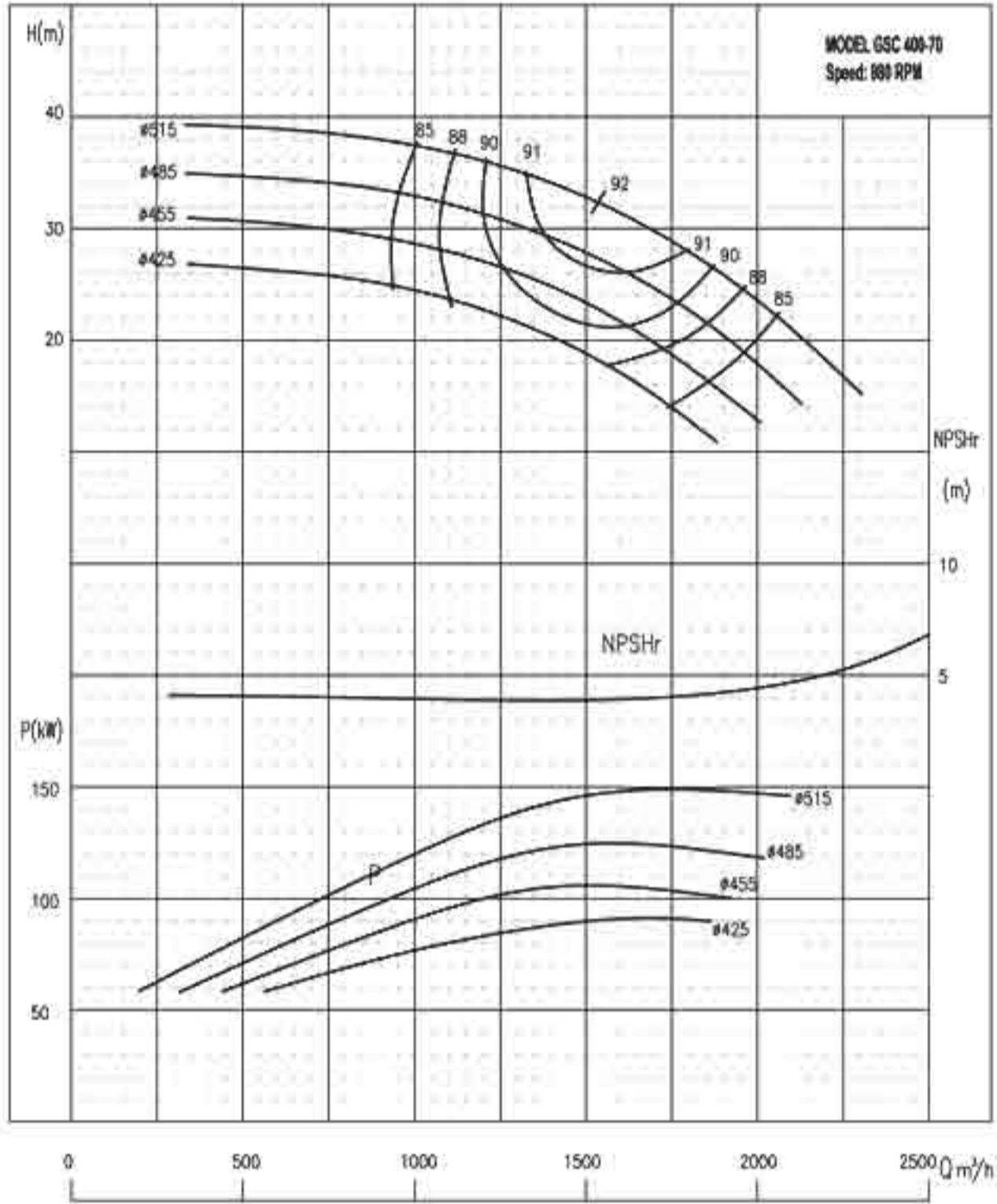

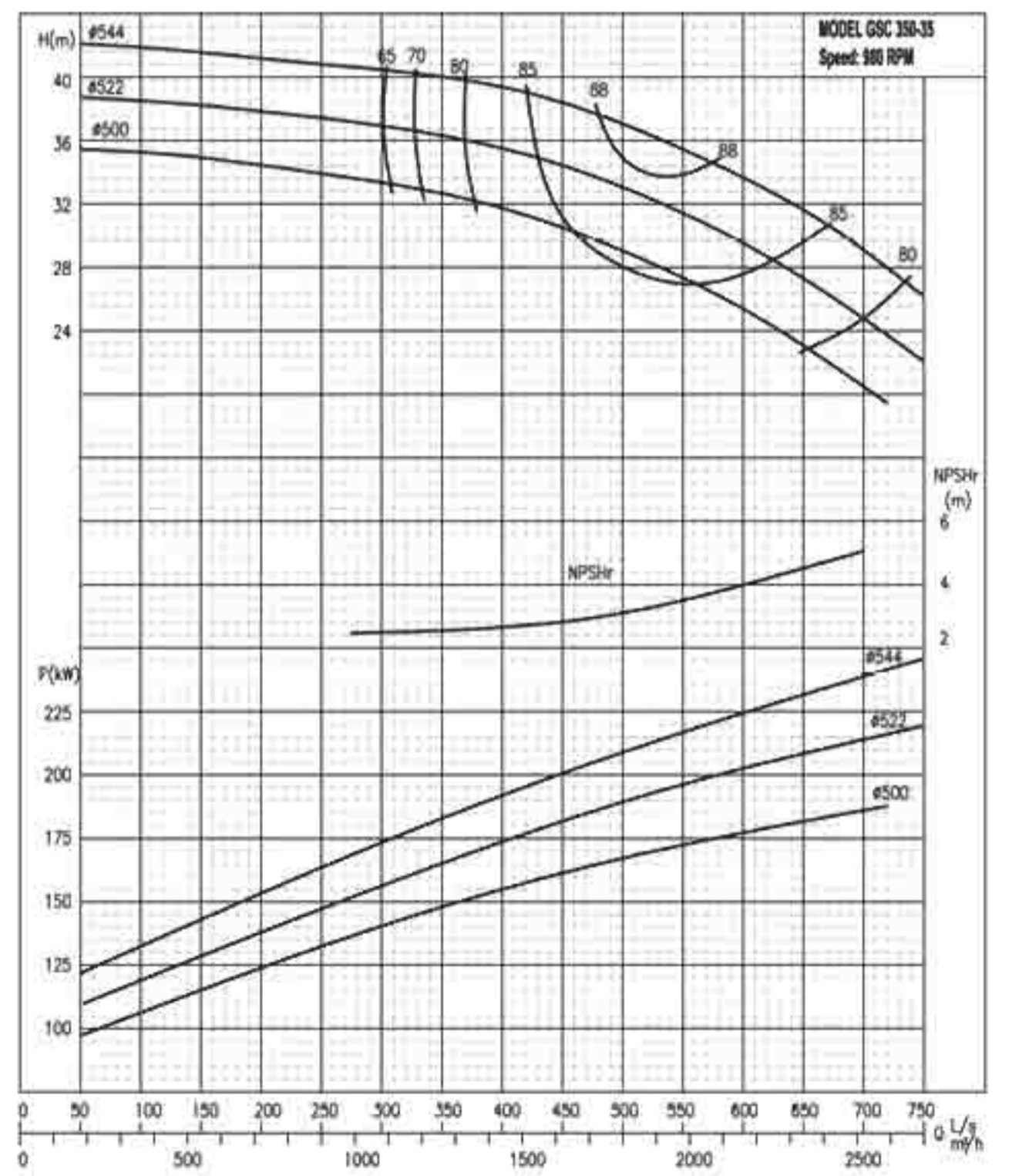
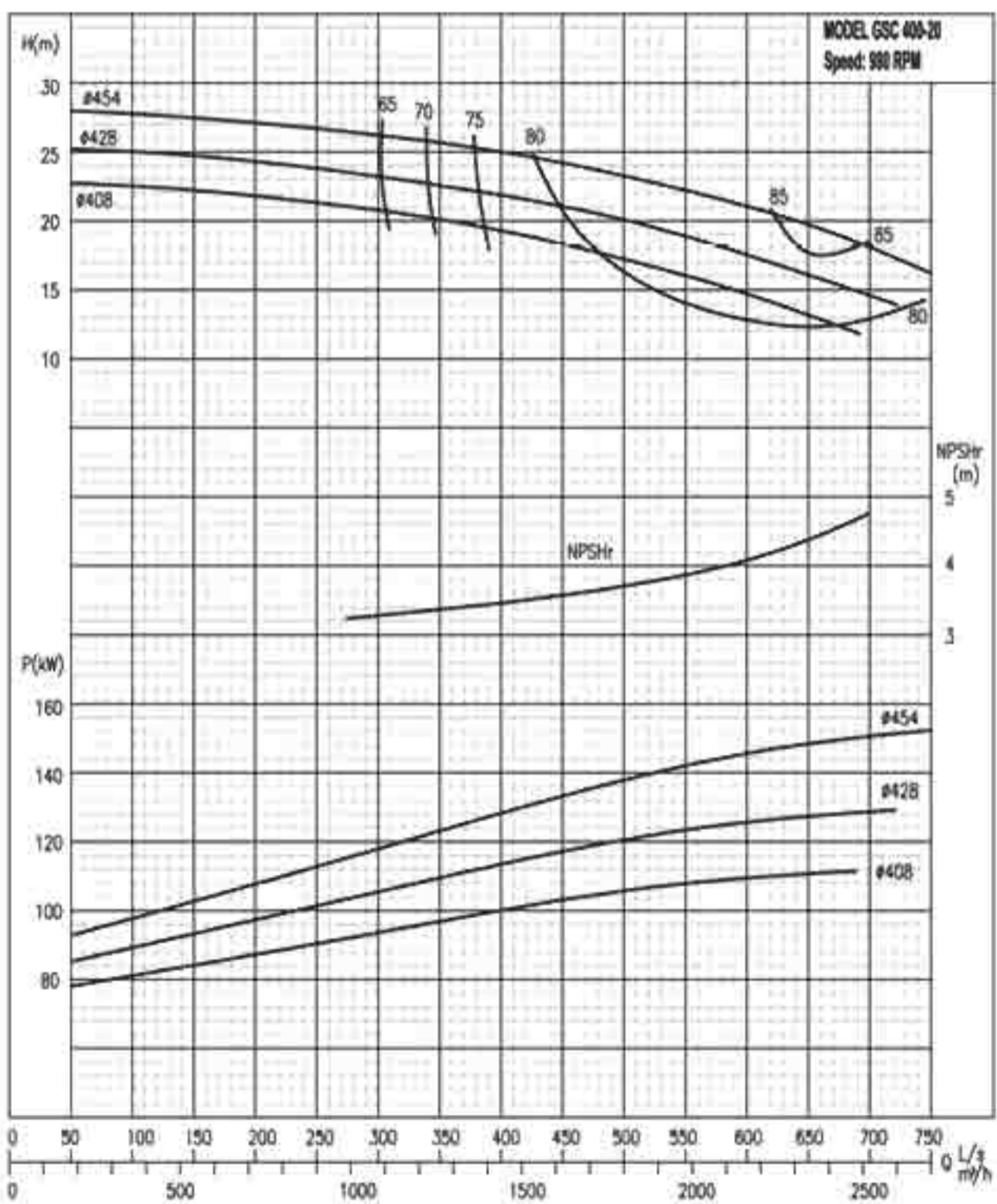
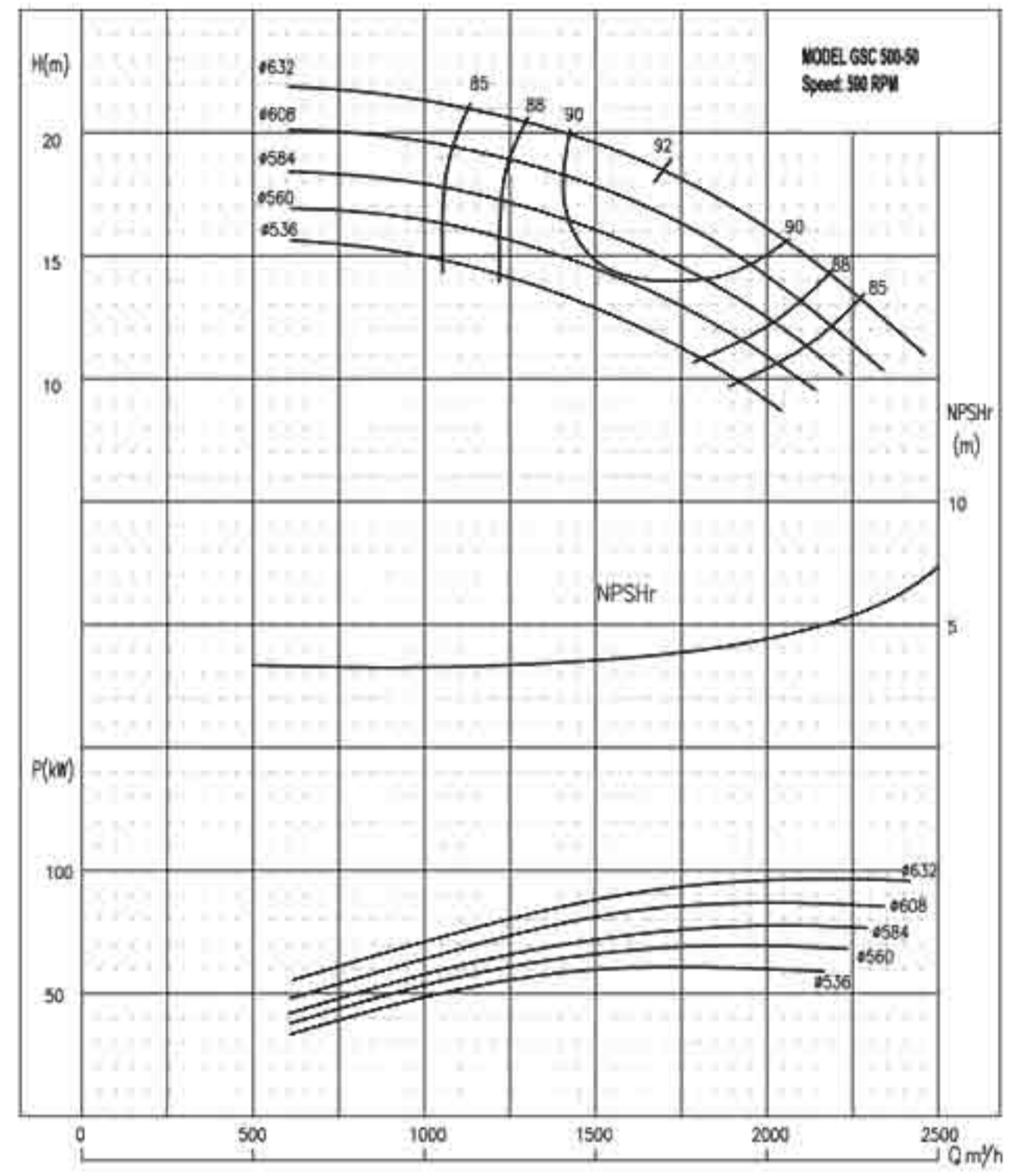
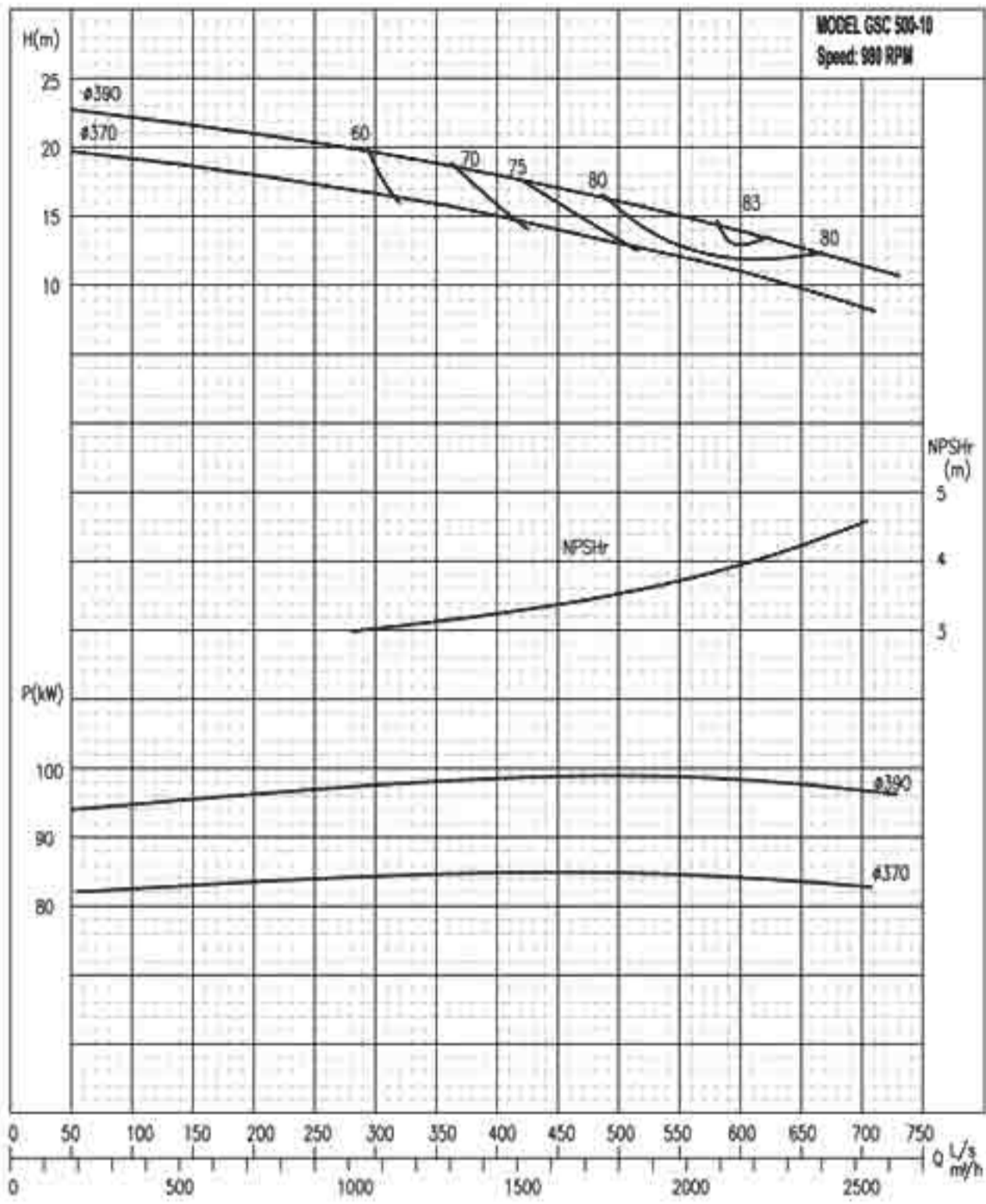



Performance Curves

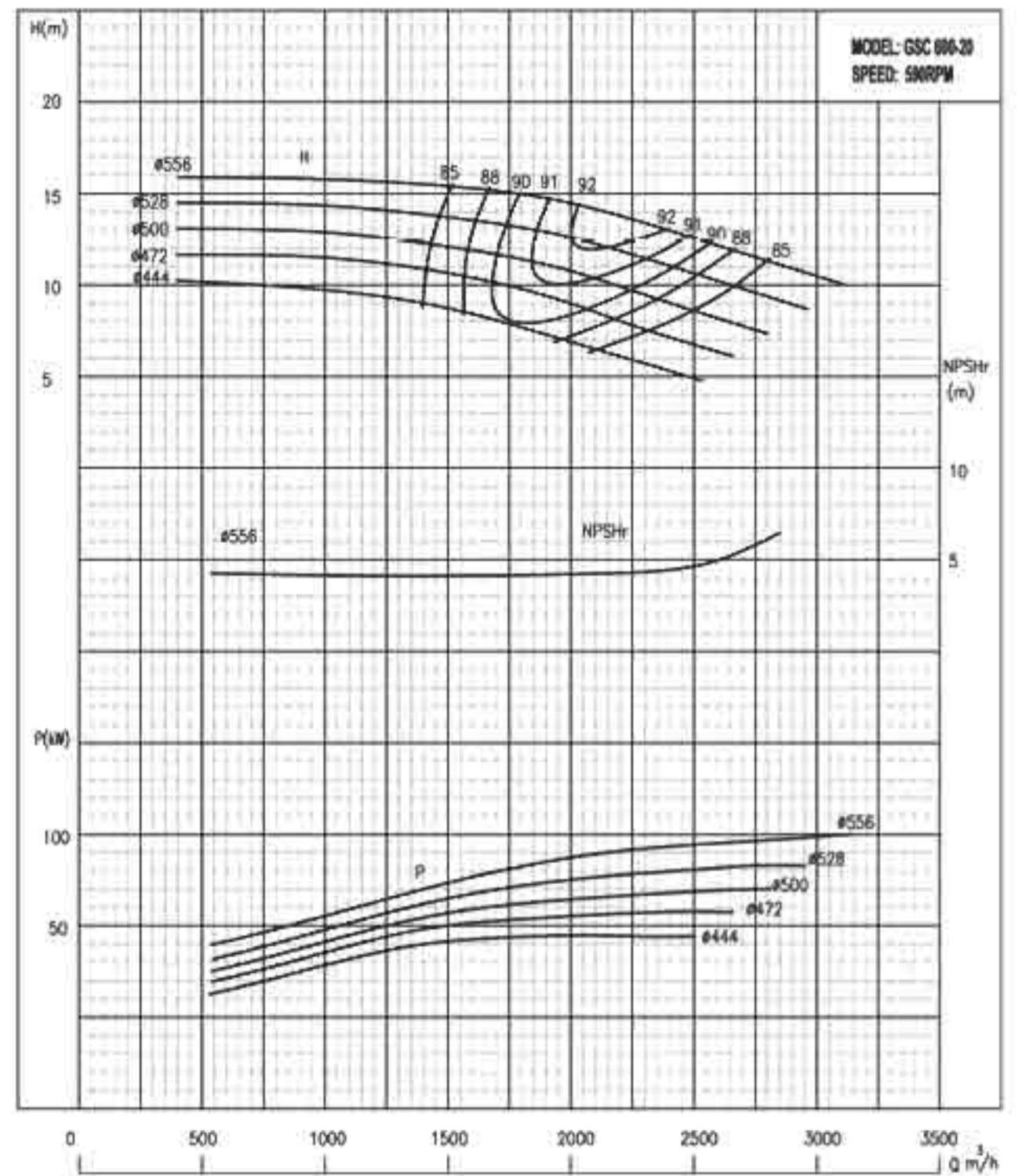
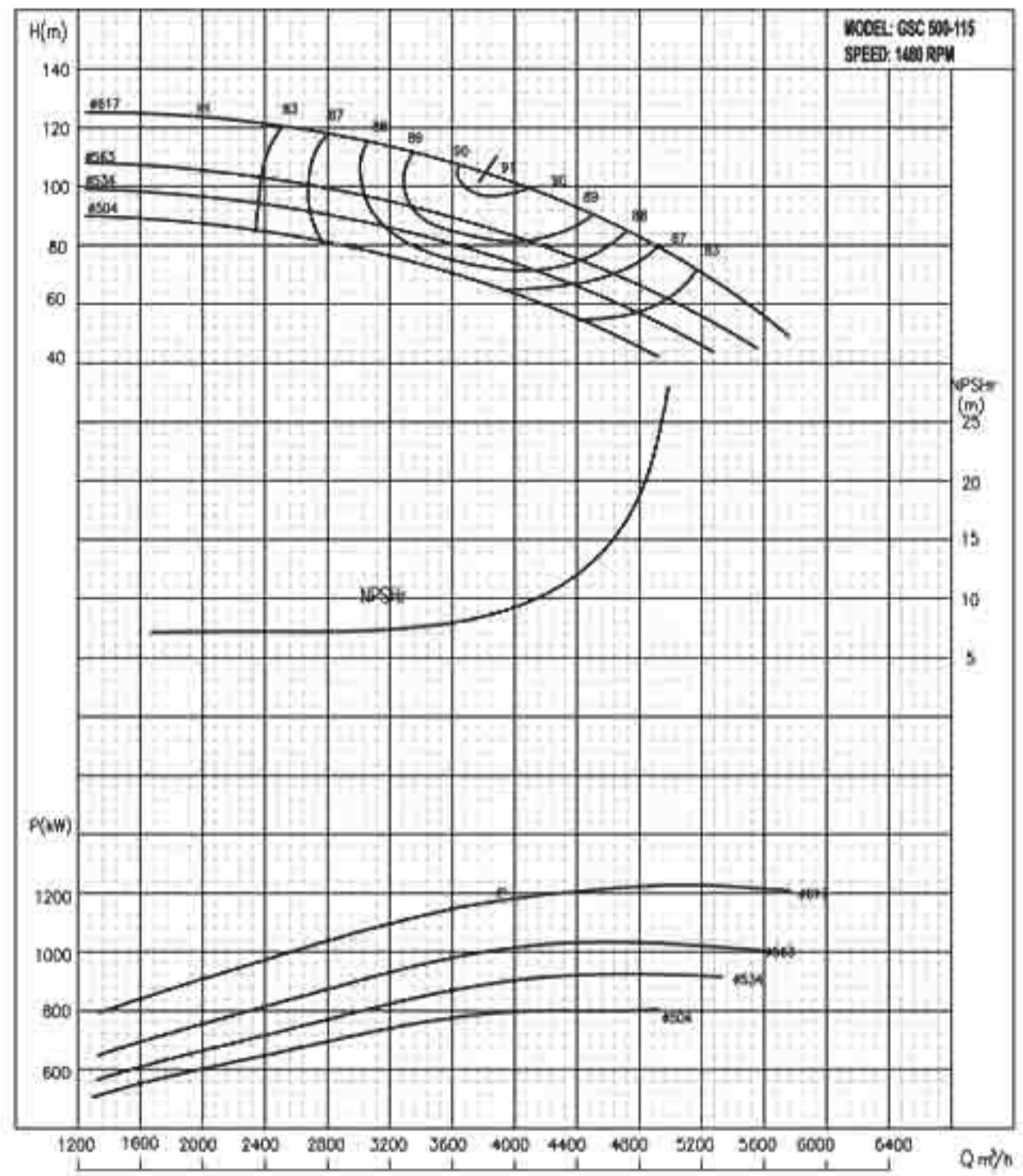
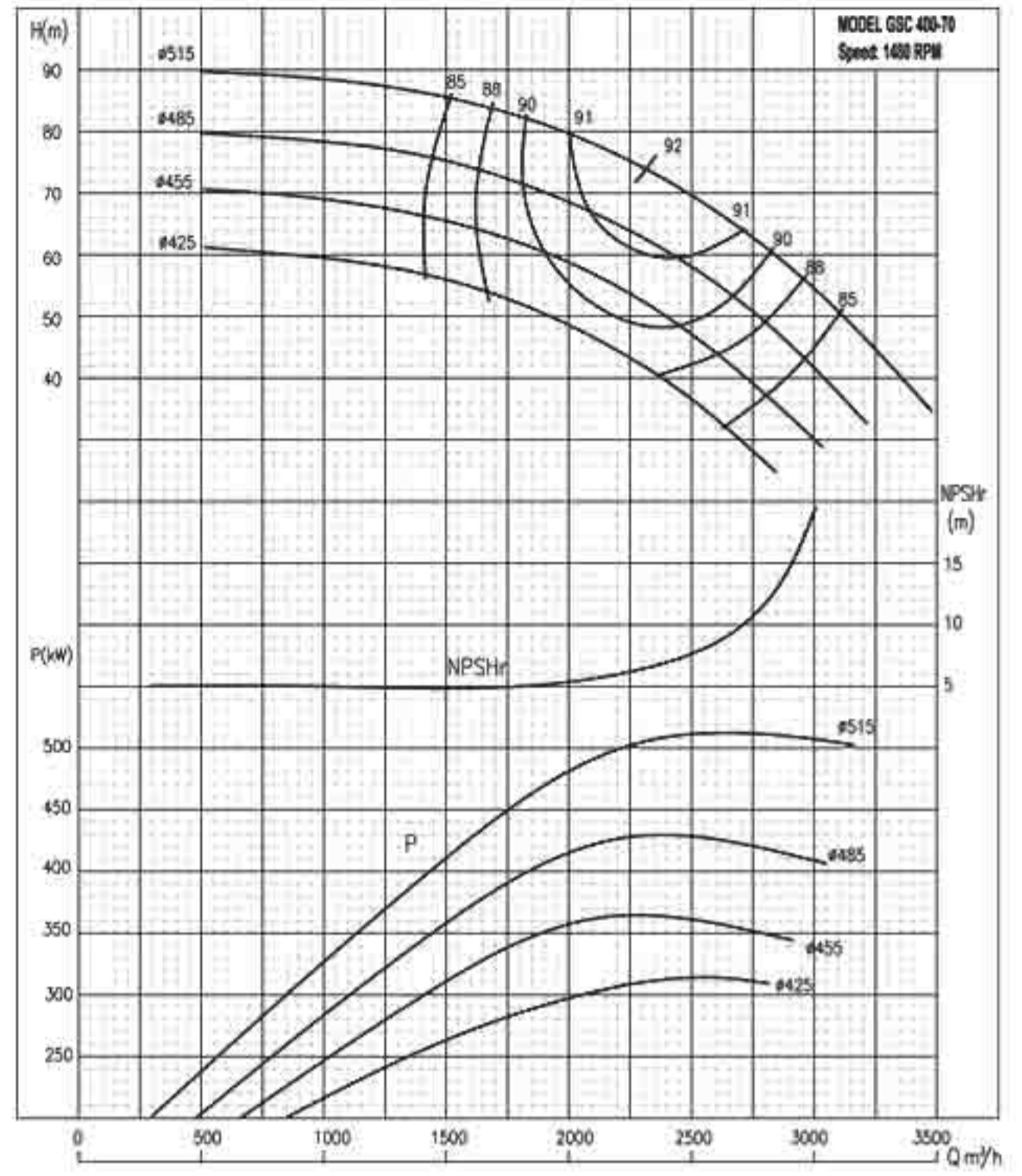
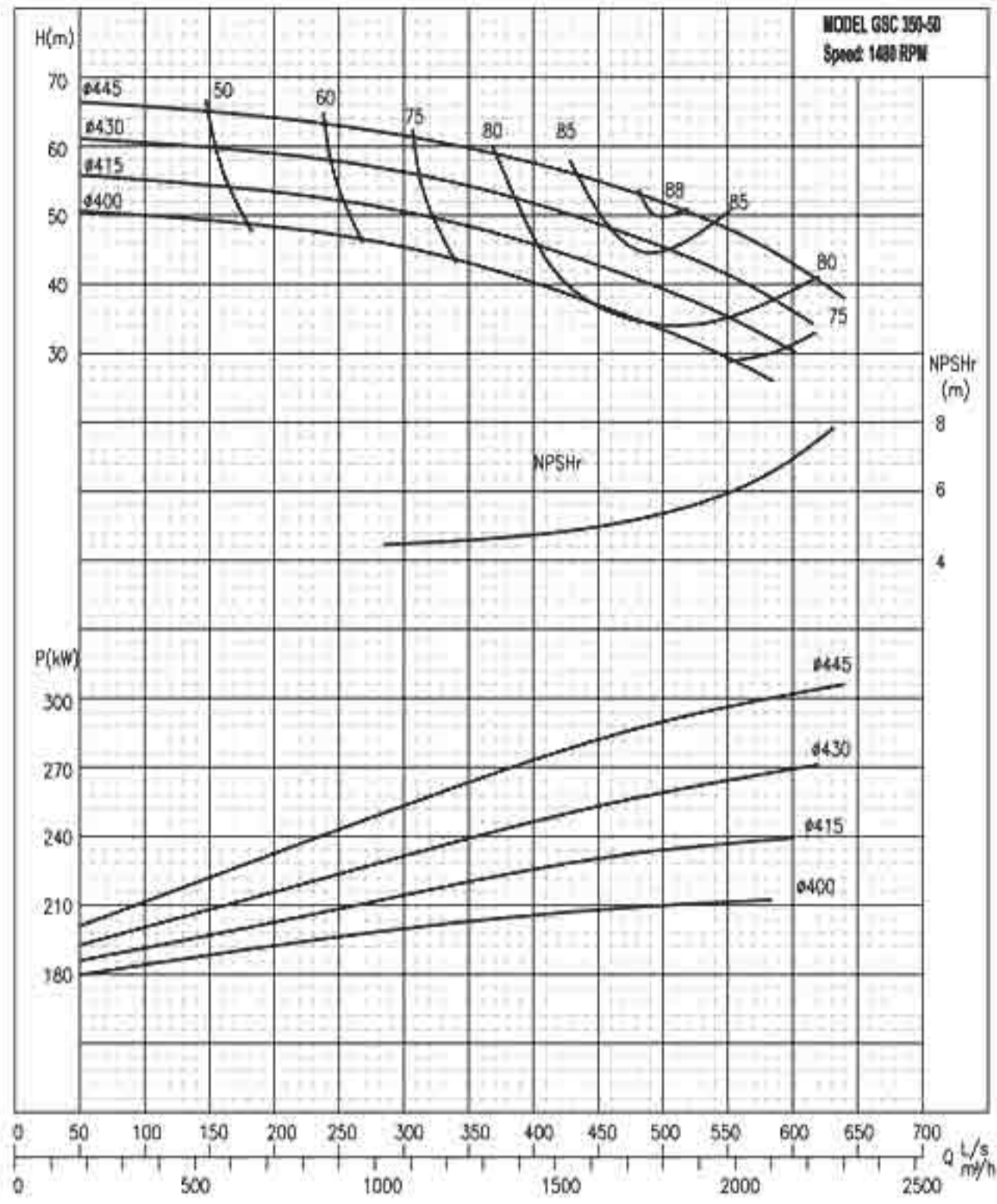

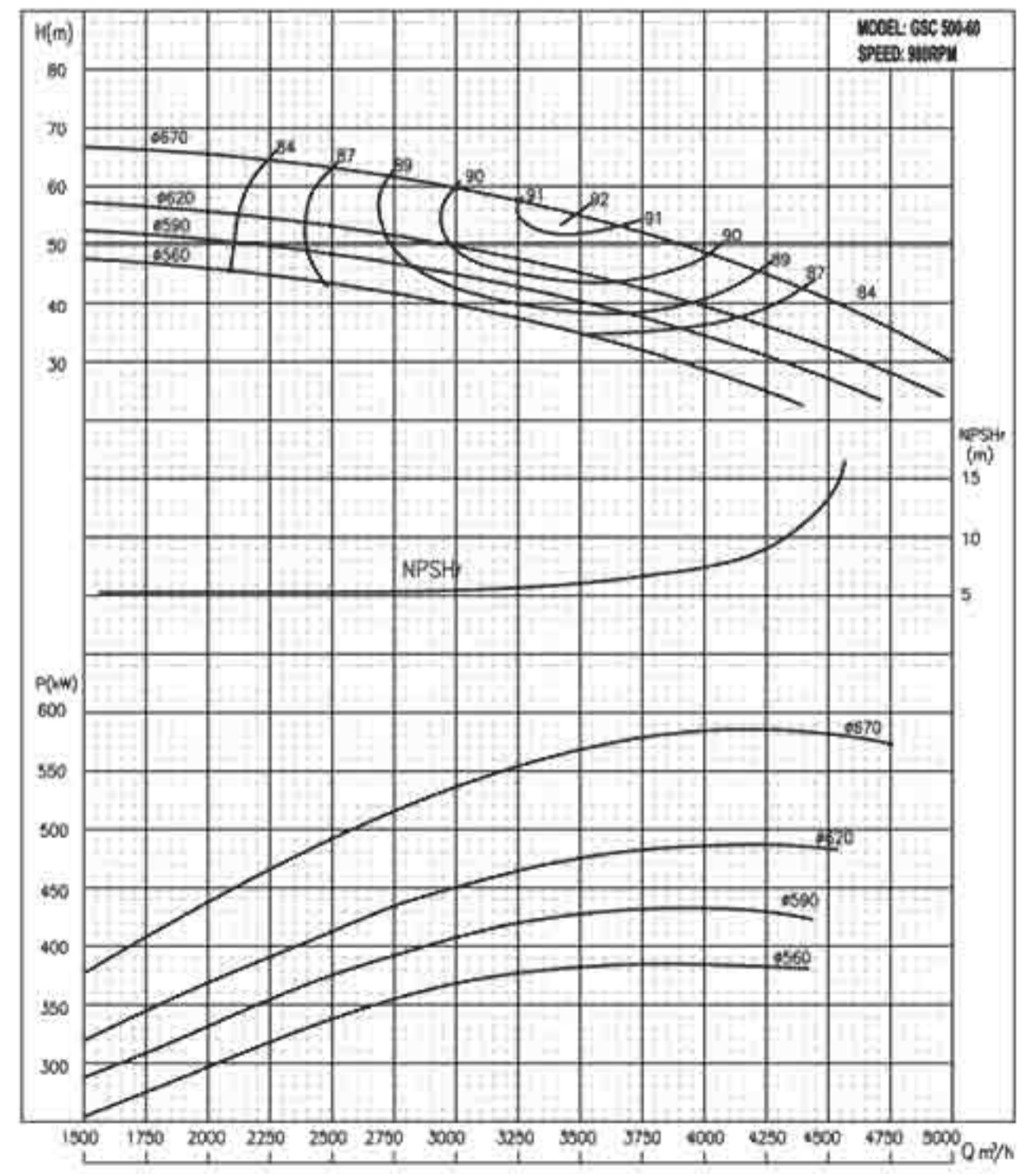
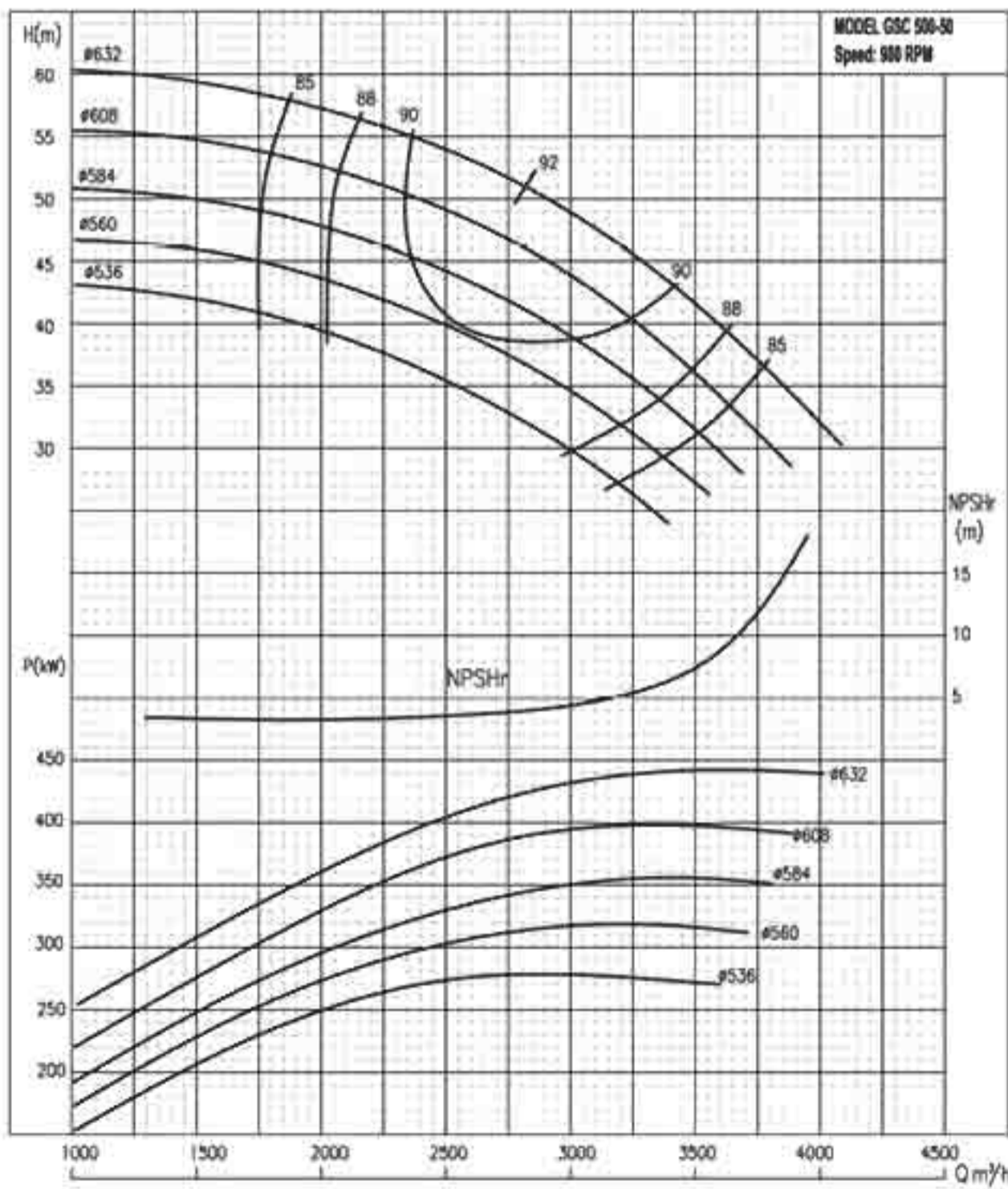
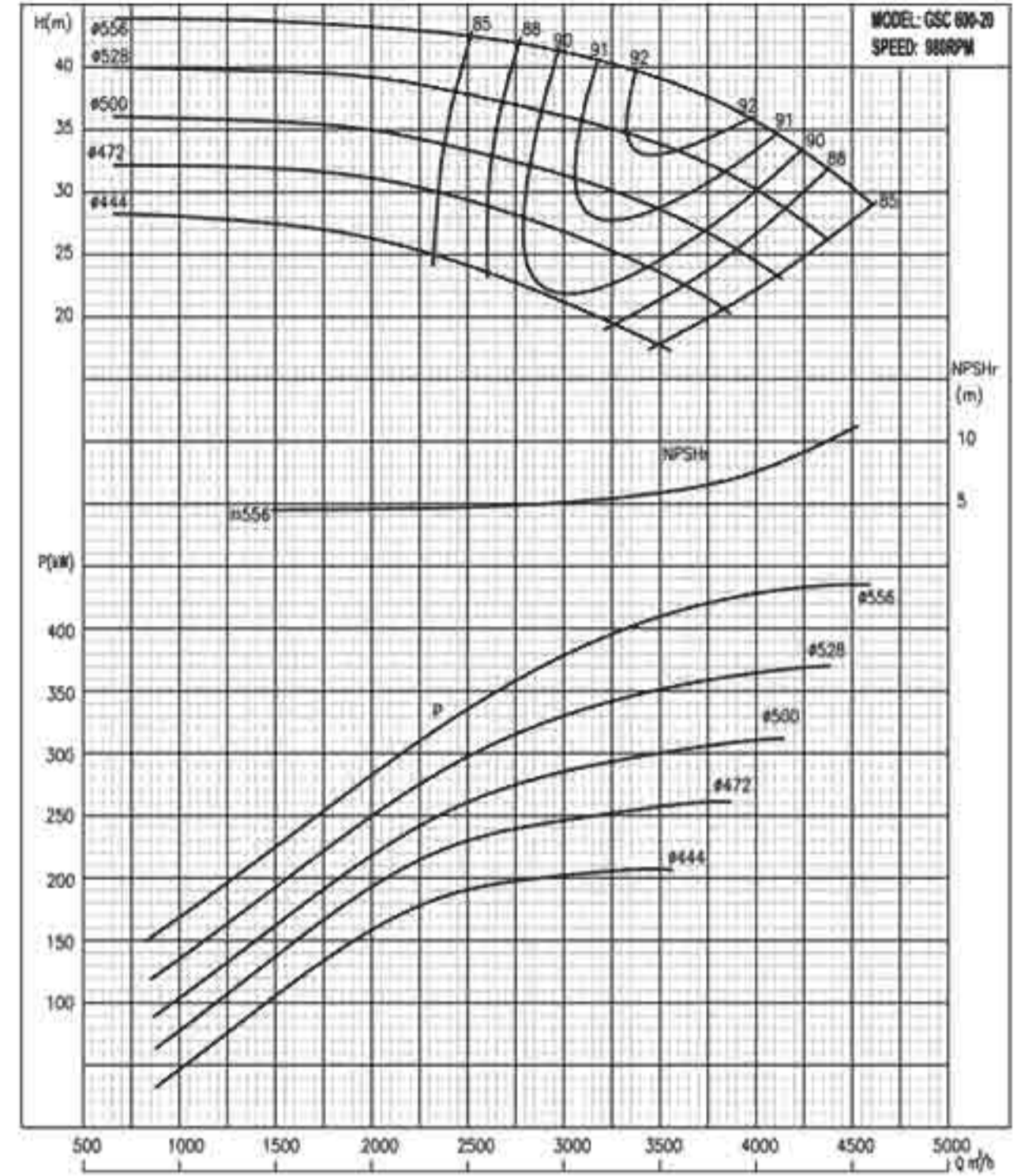
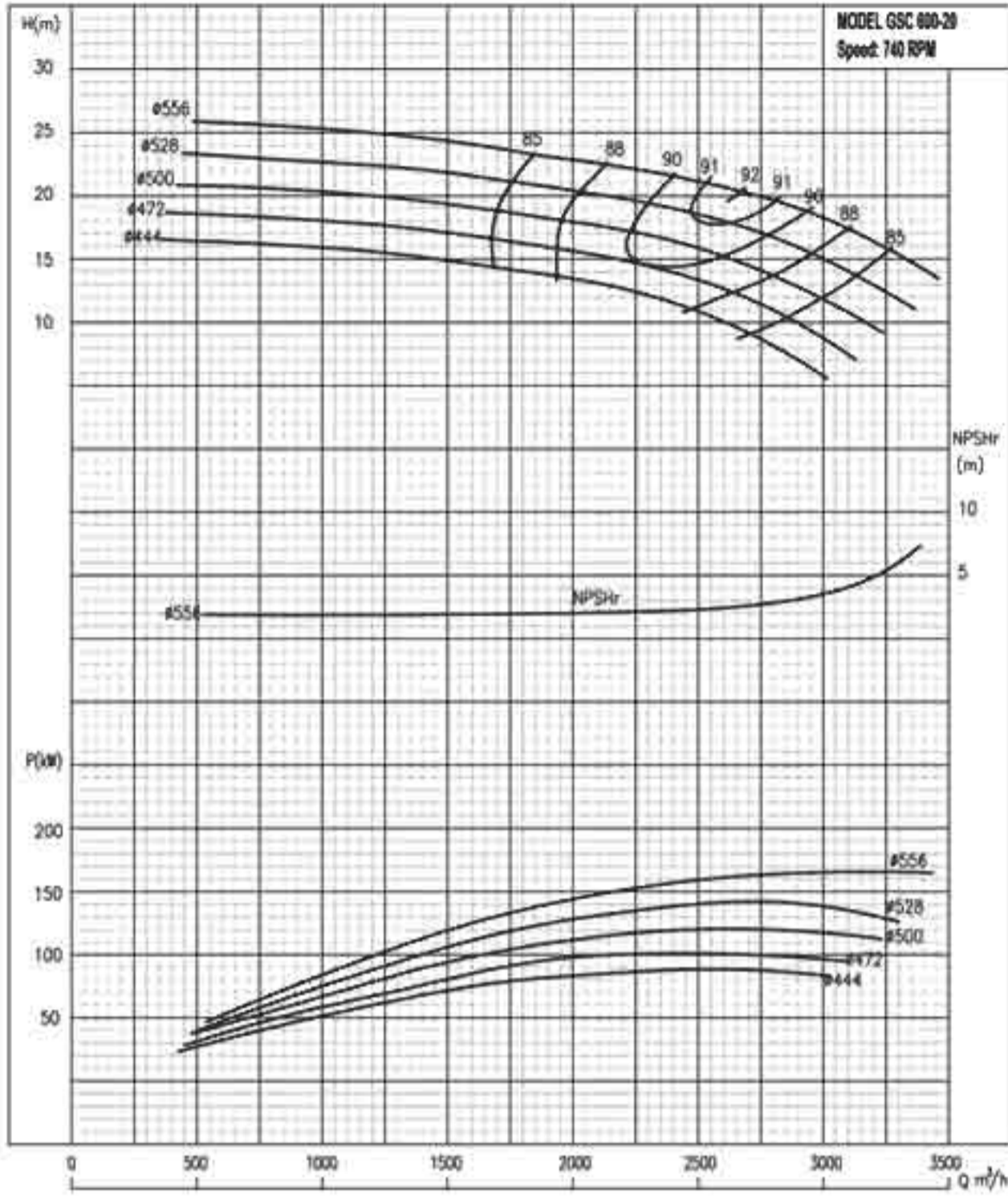



Performance Curves

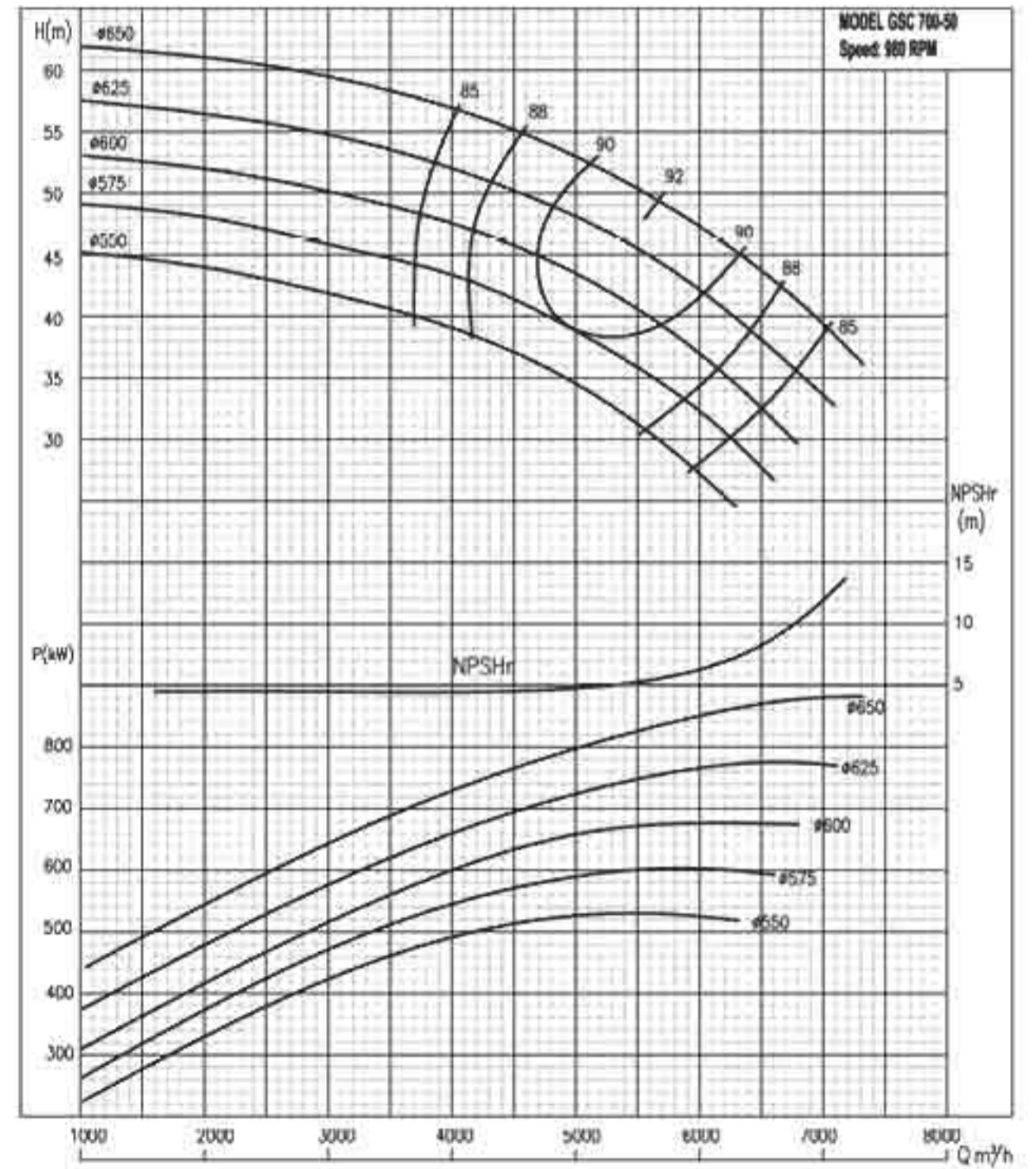
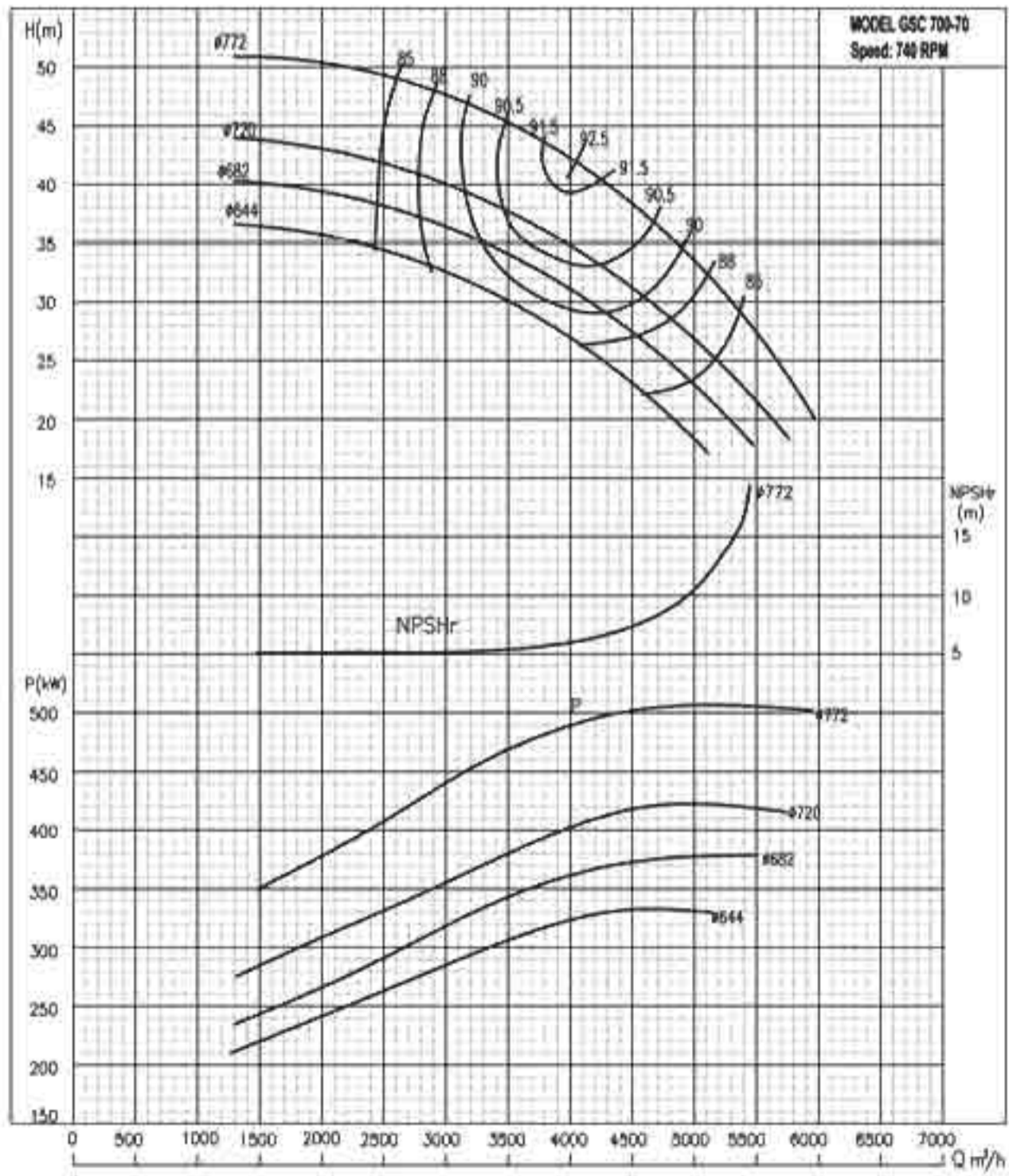
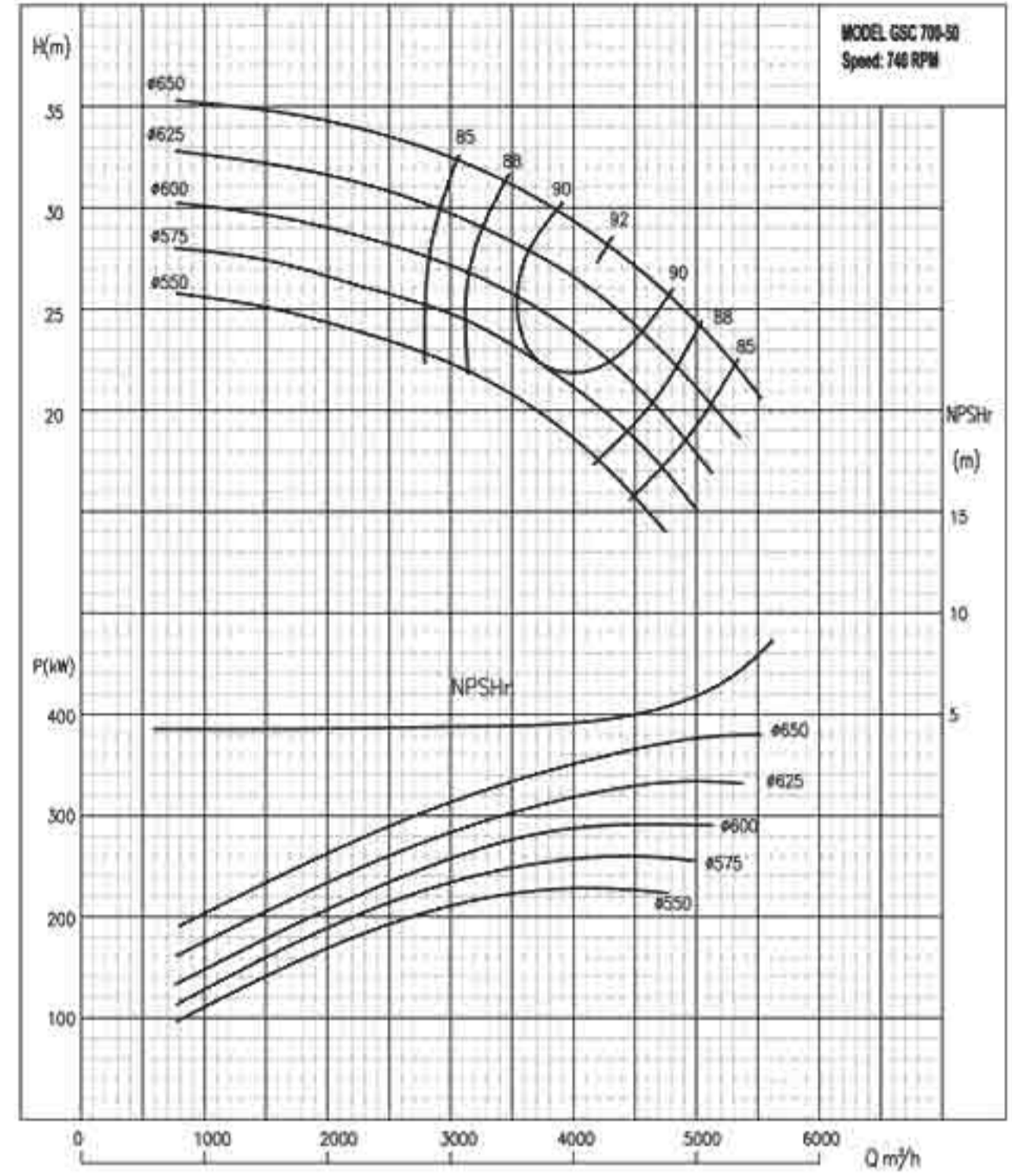
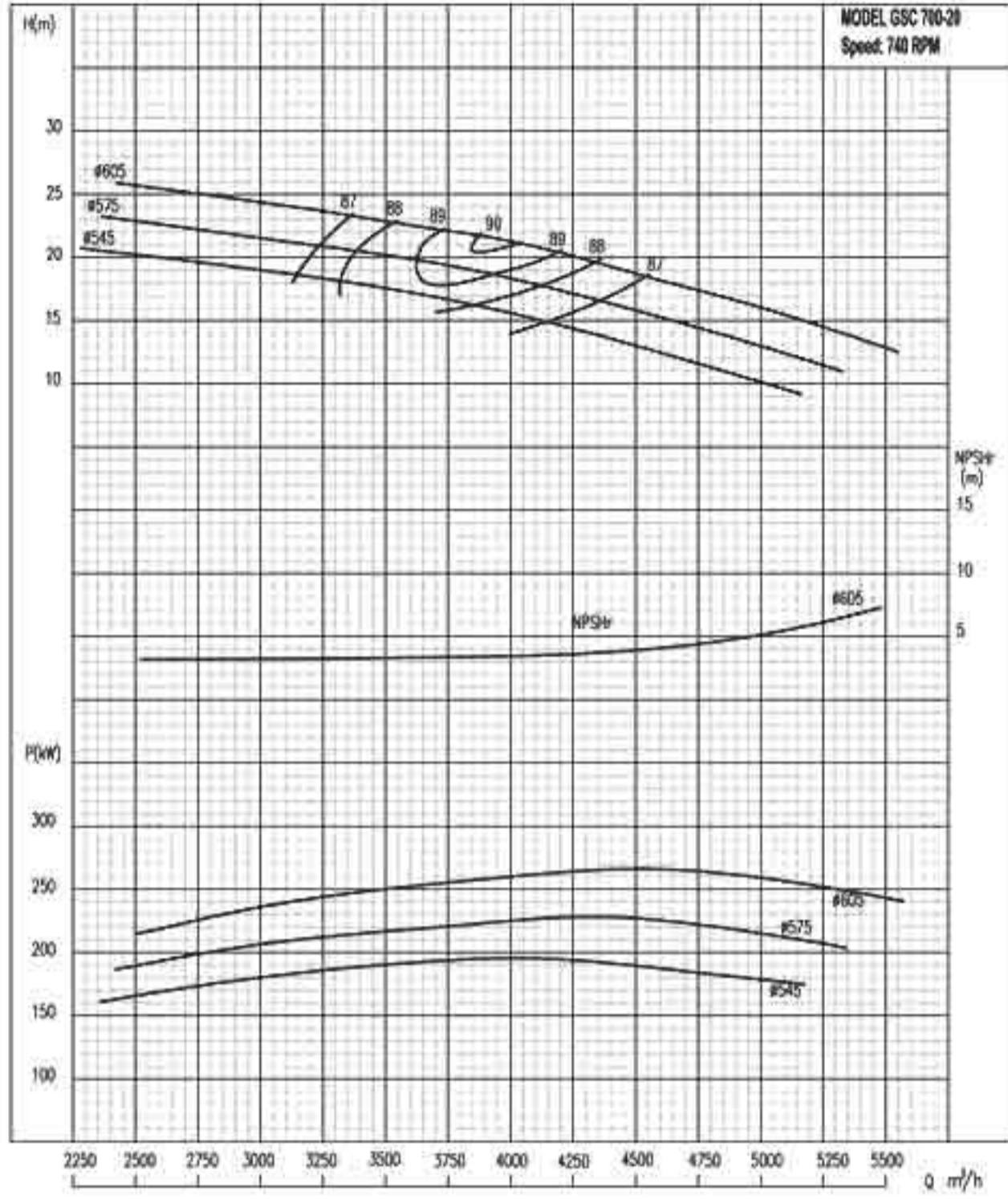

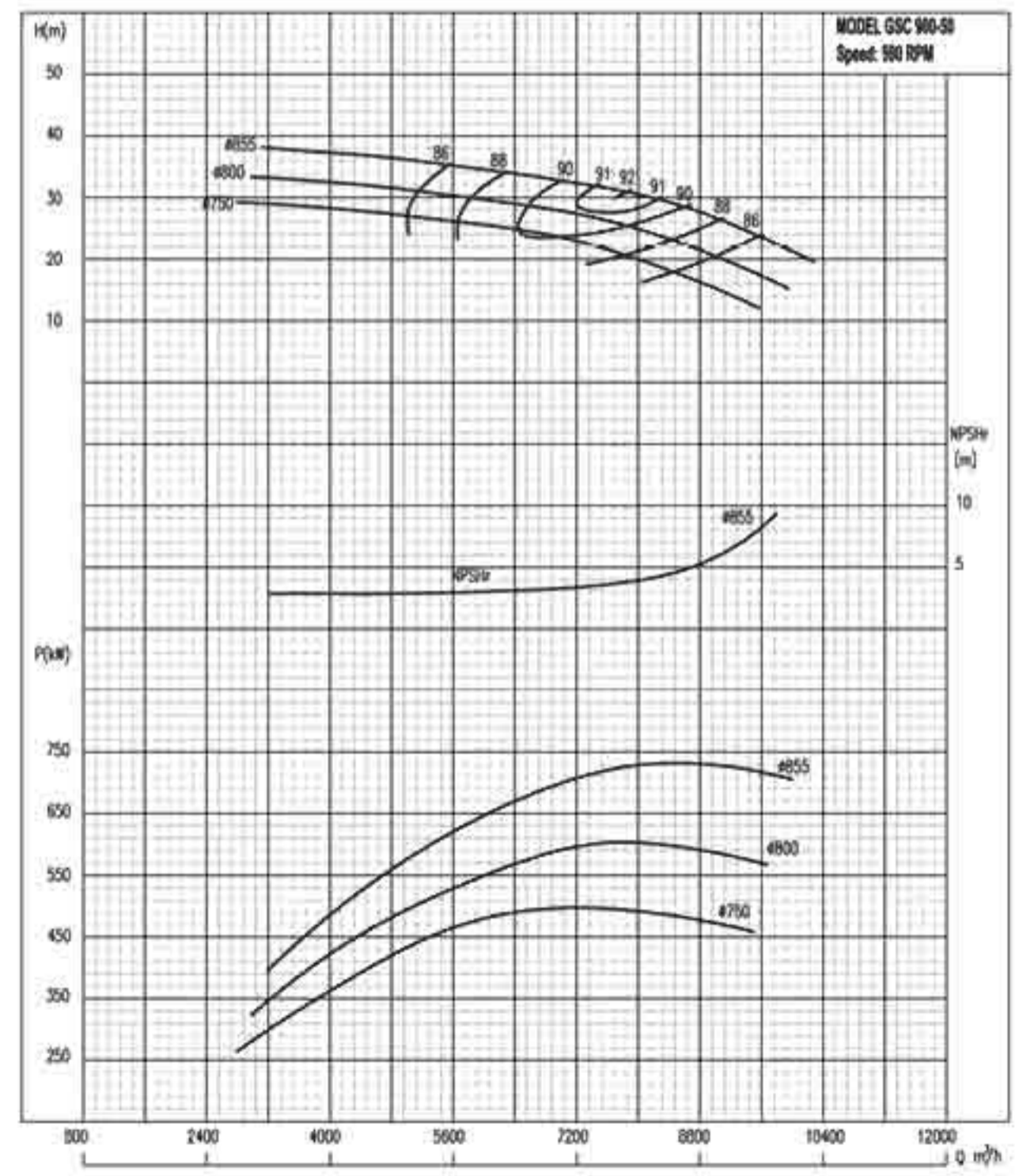
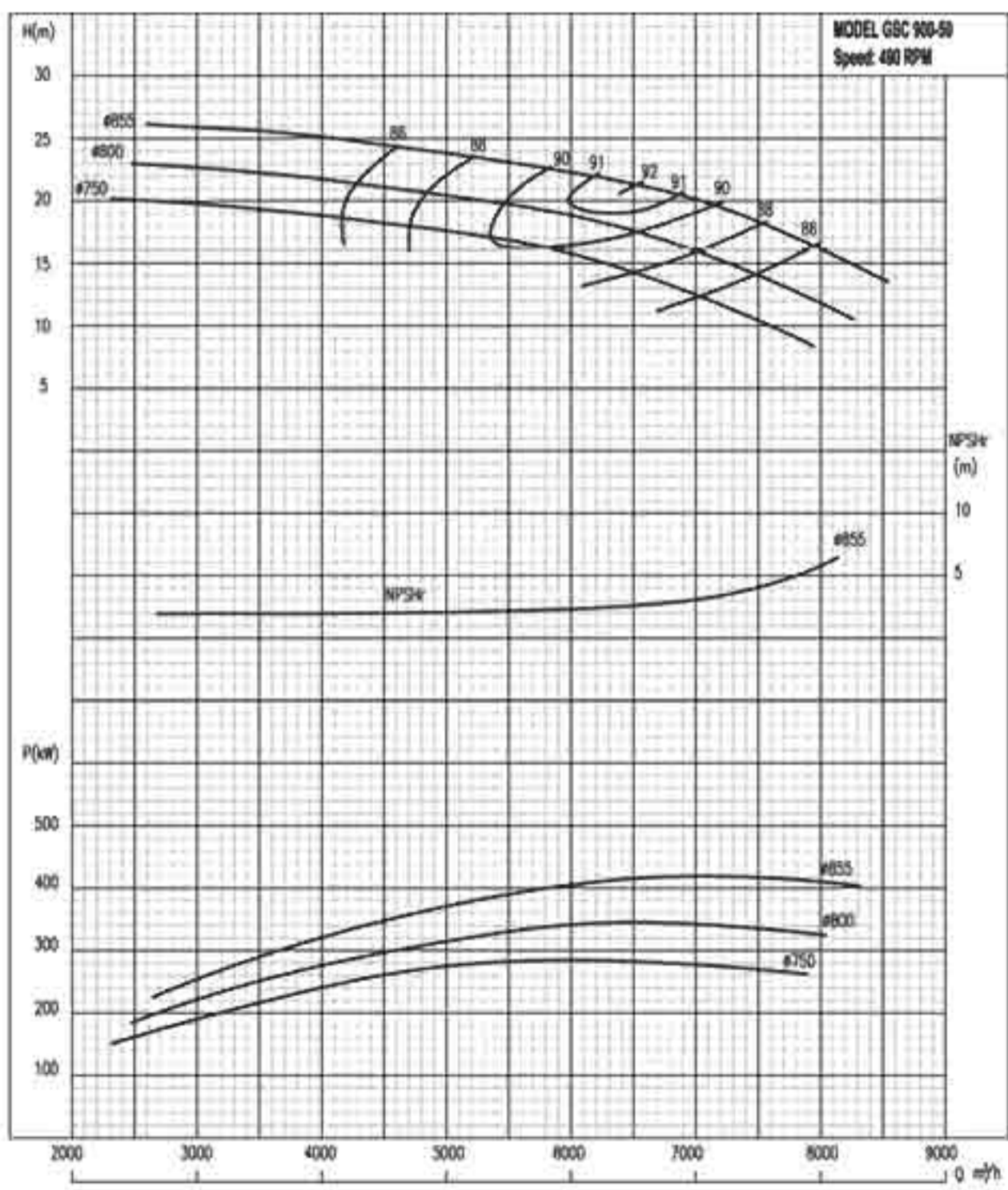
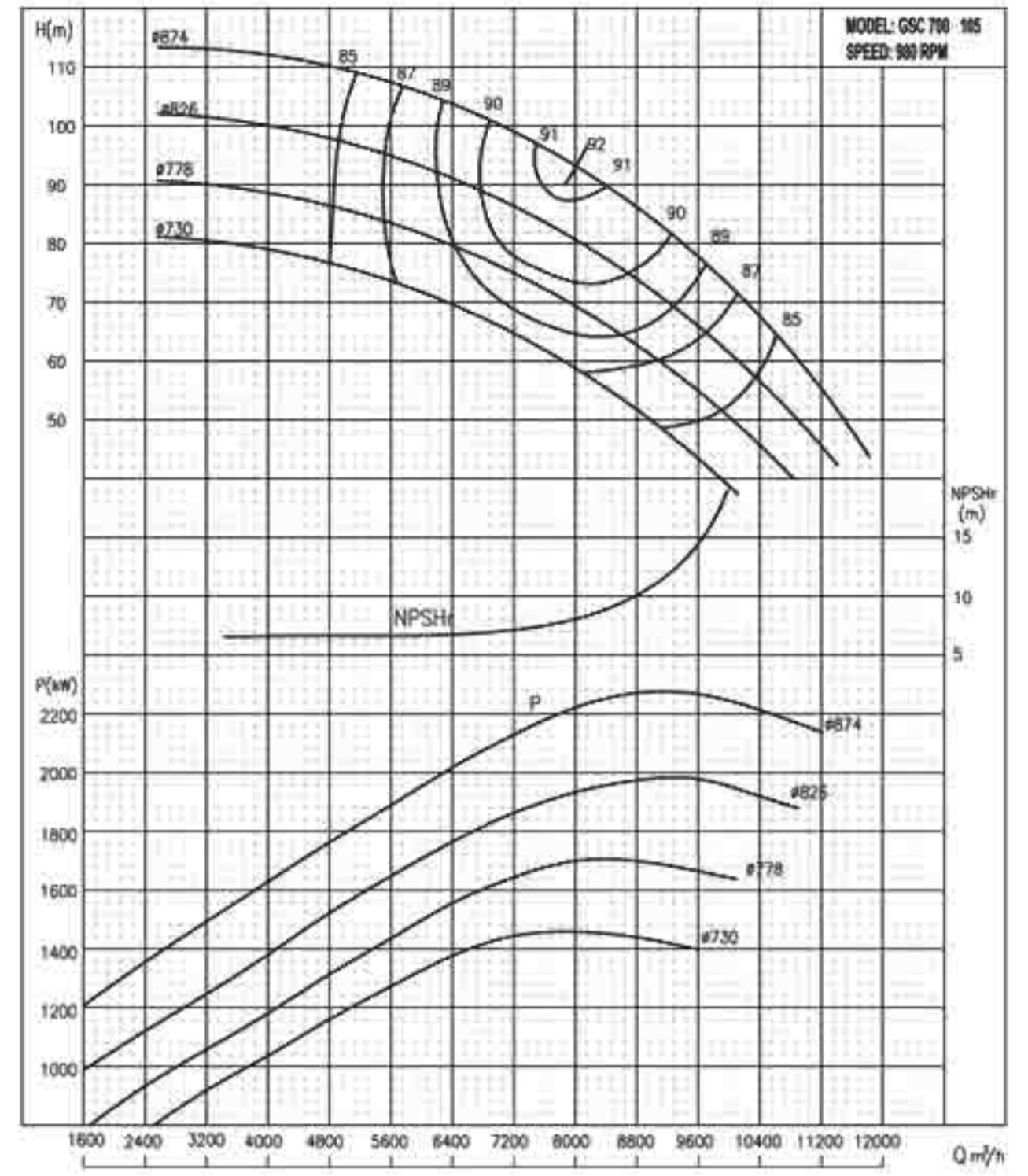
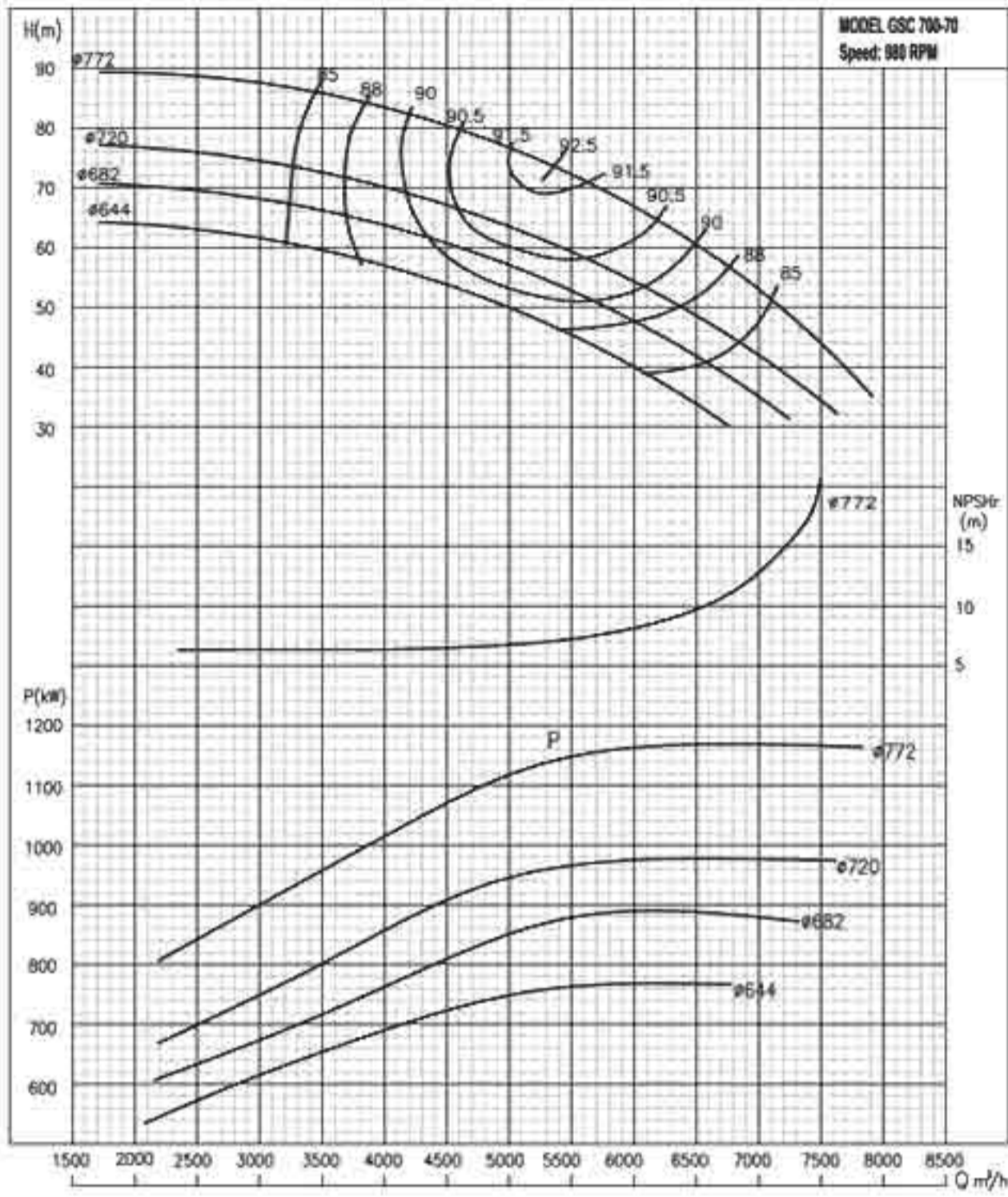



Performance Curves

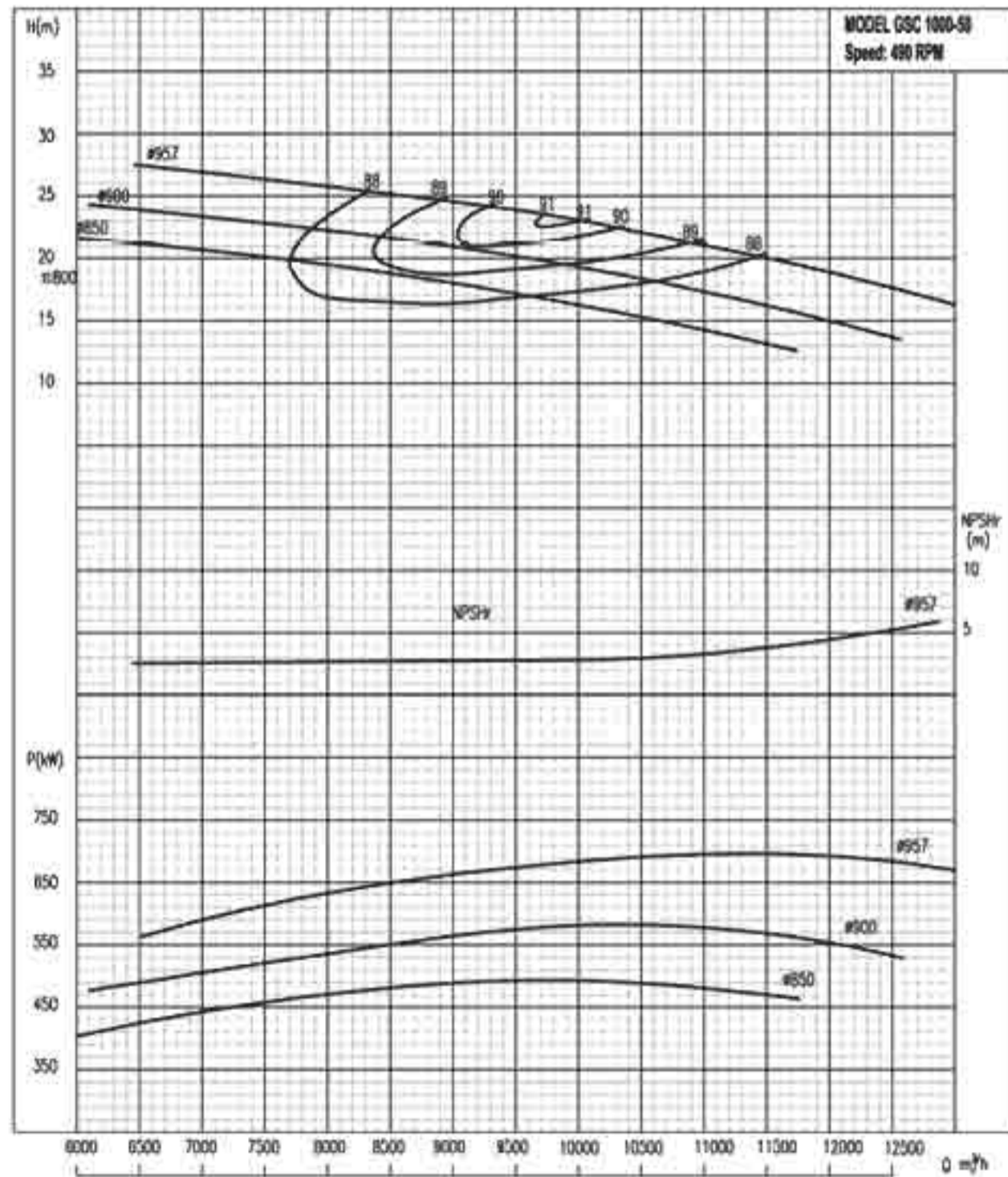
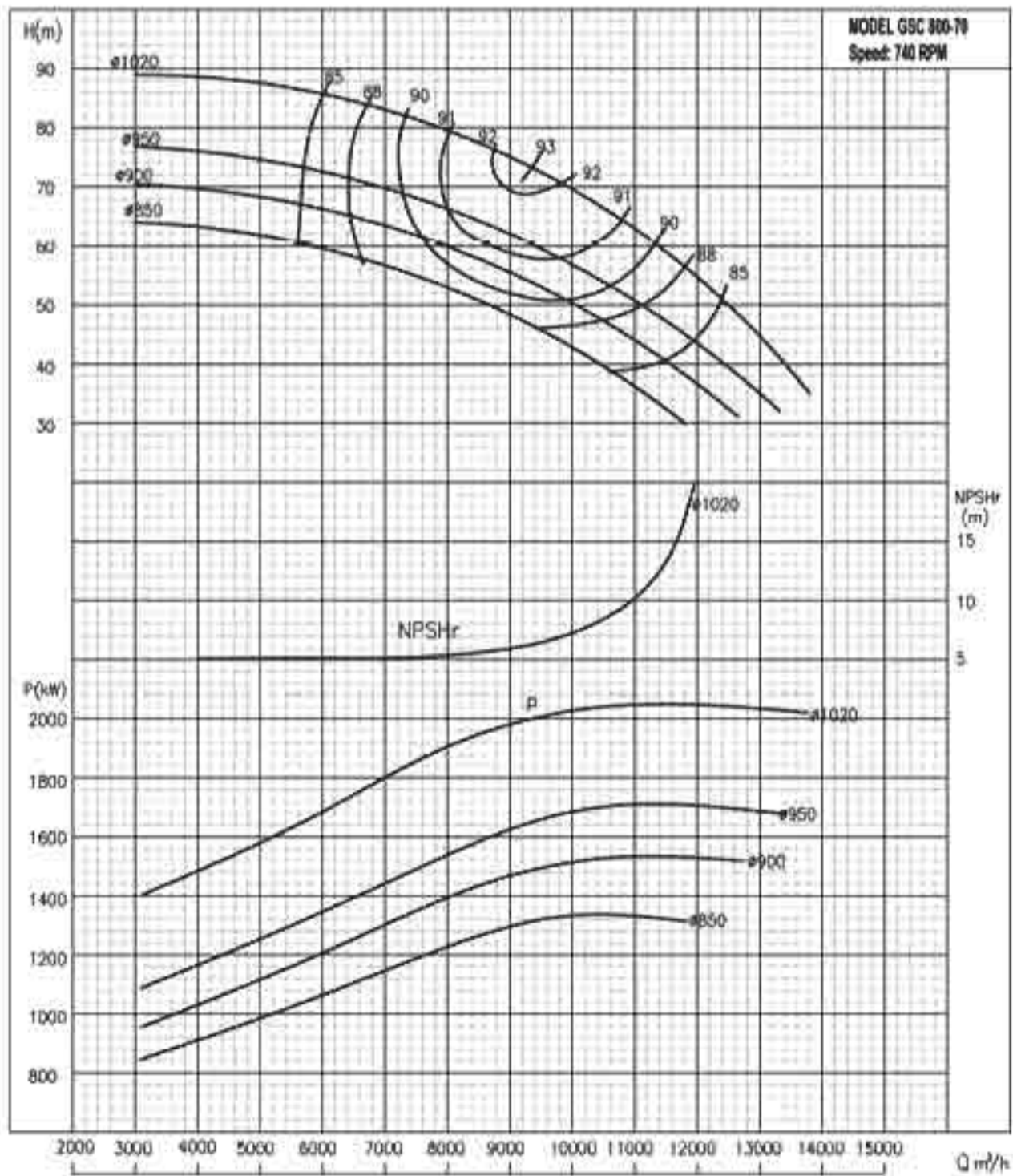
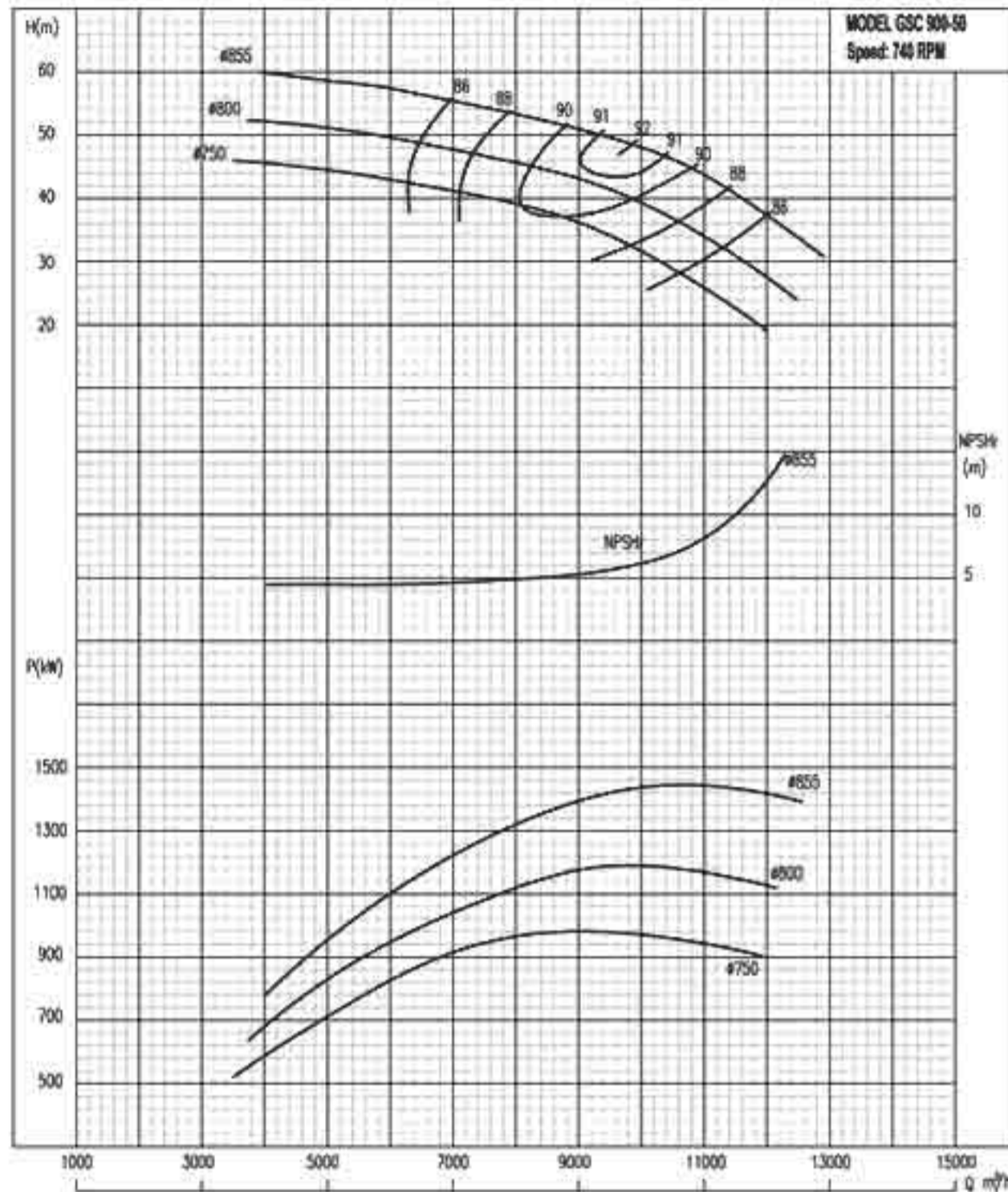
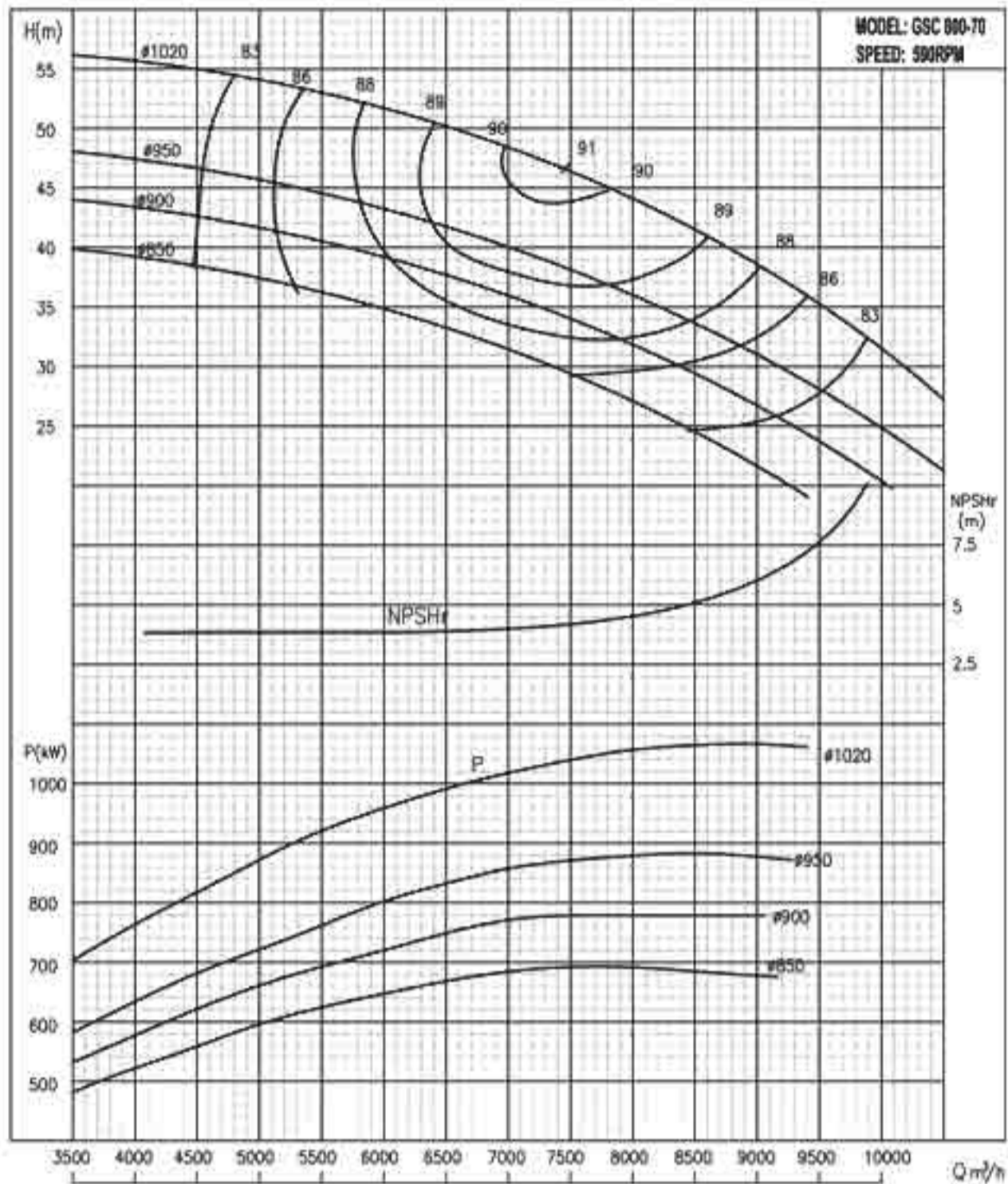

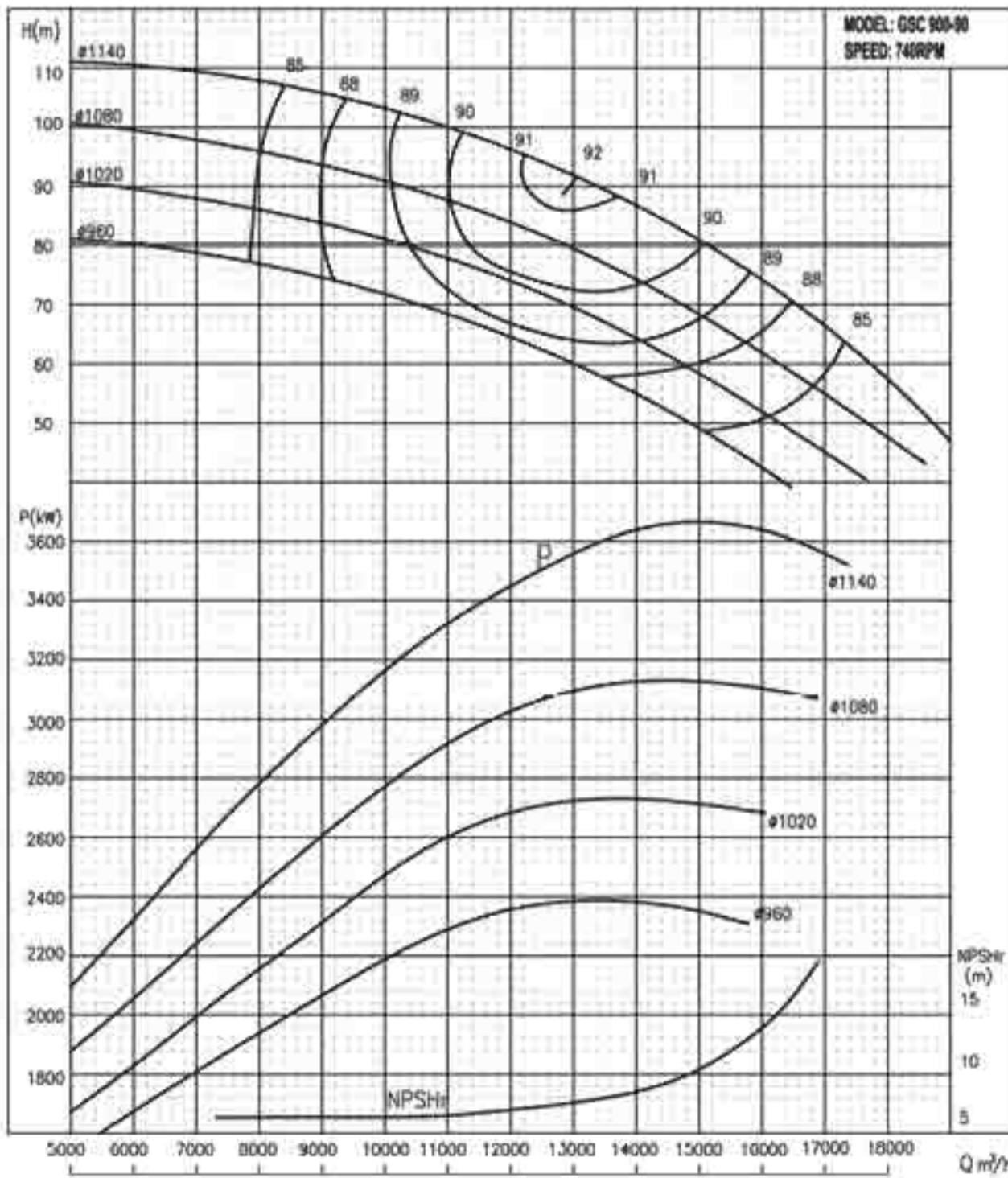
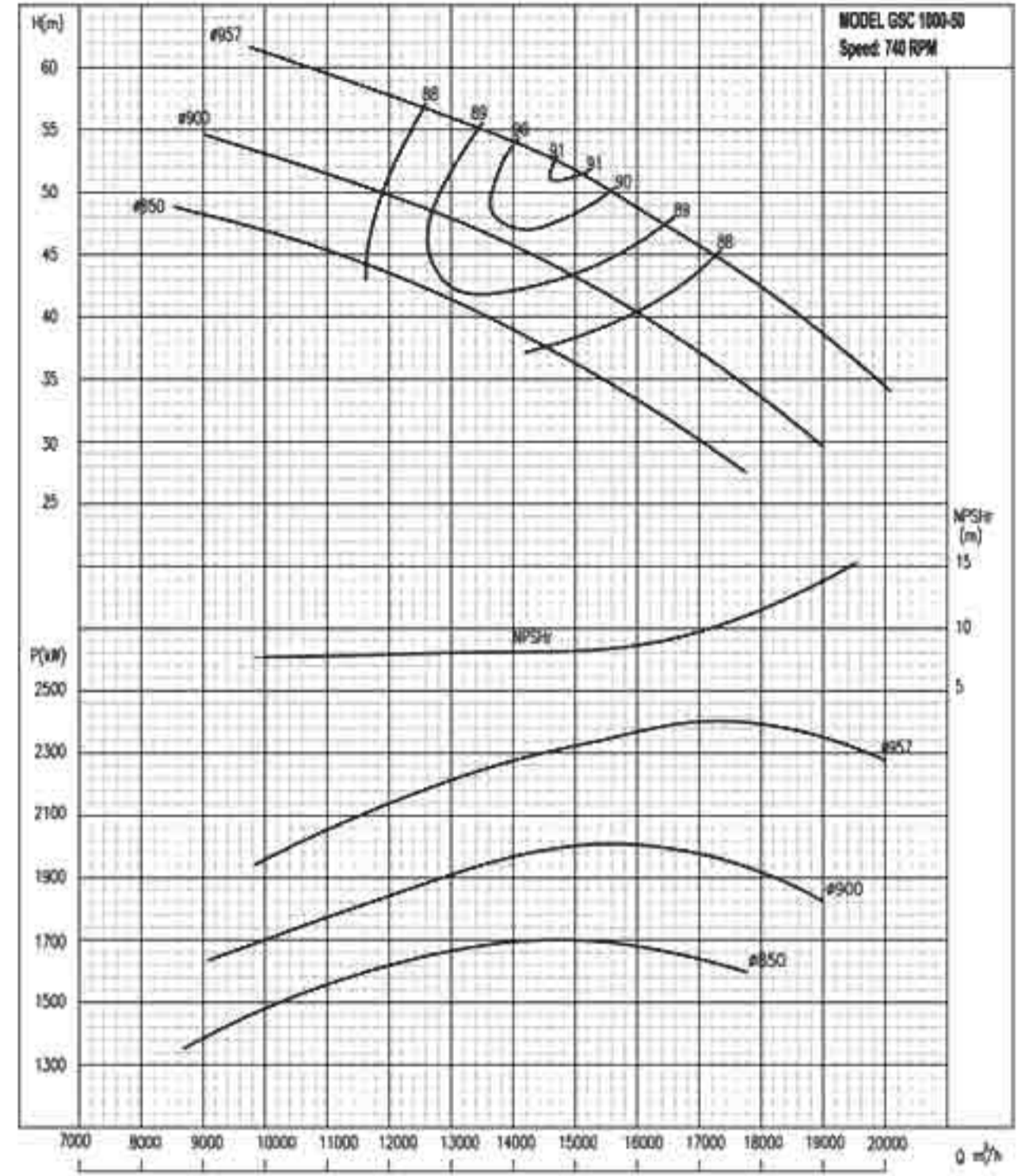
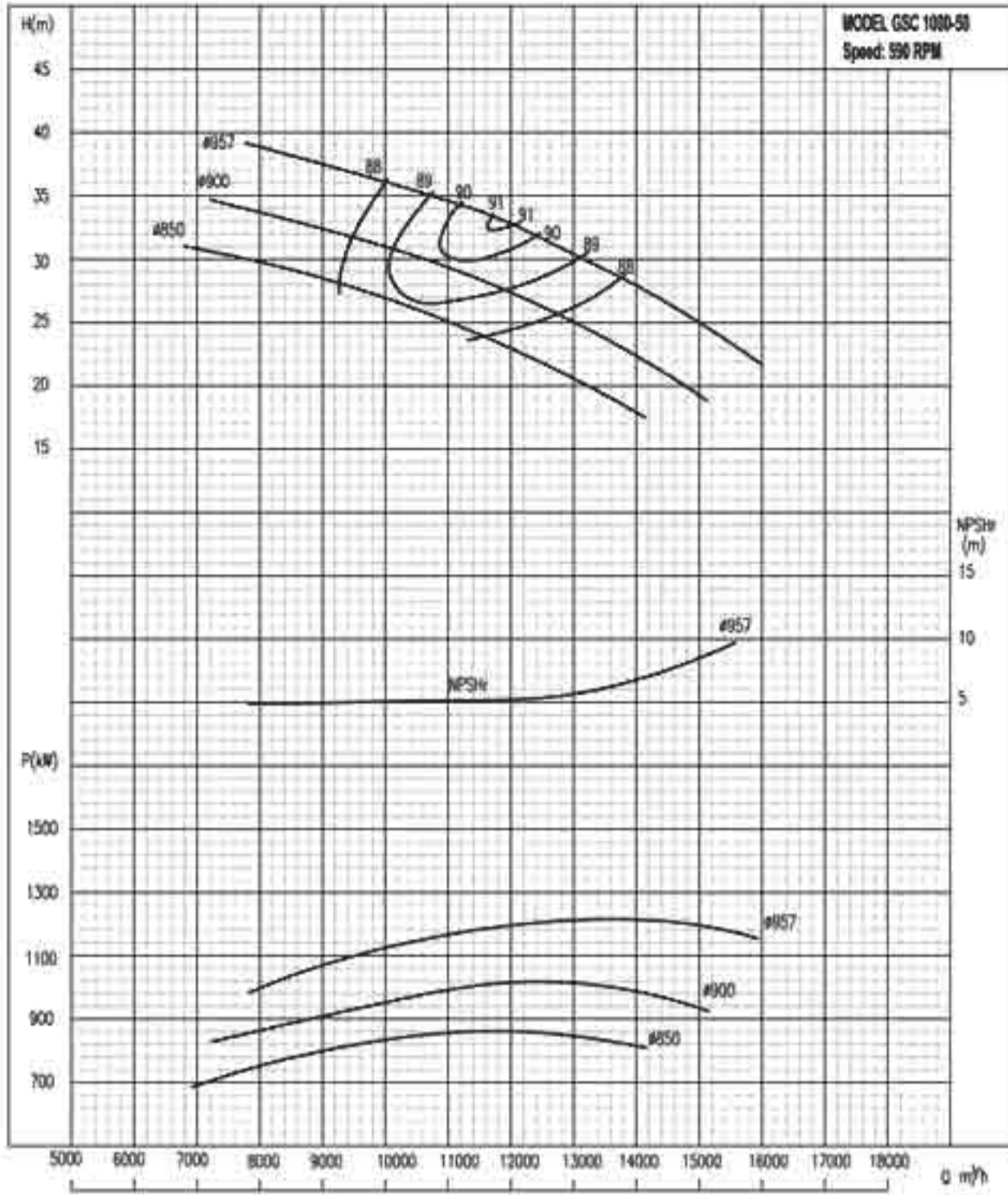

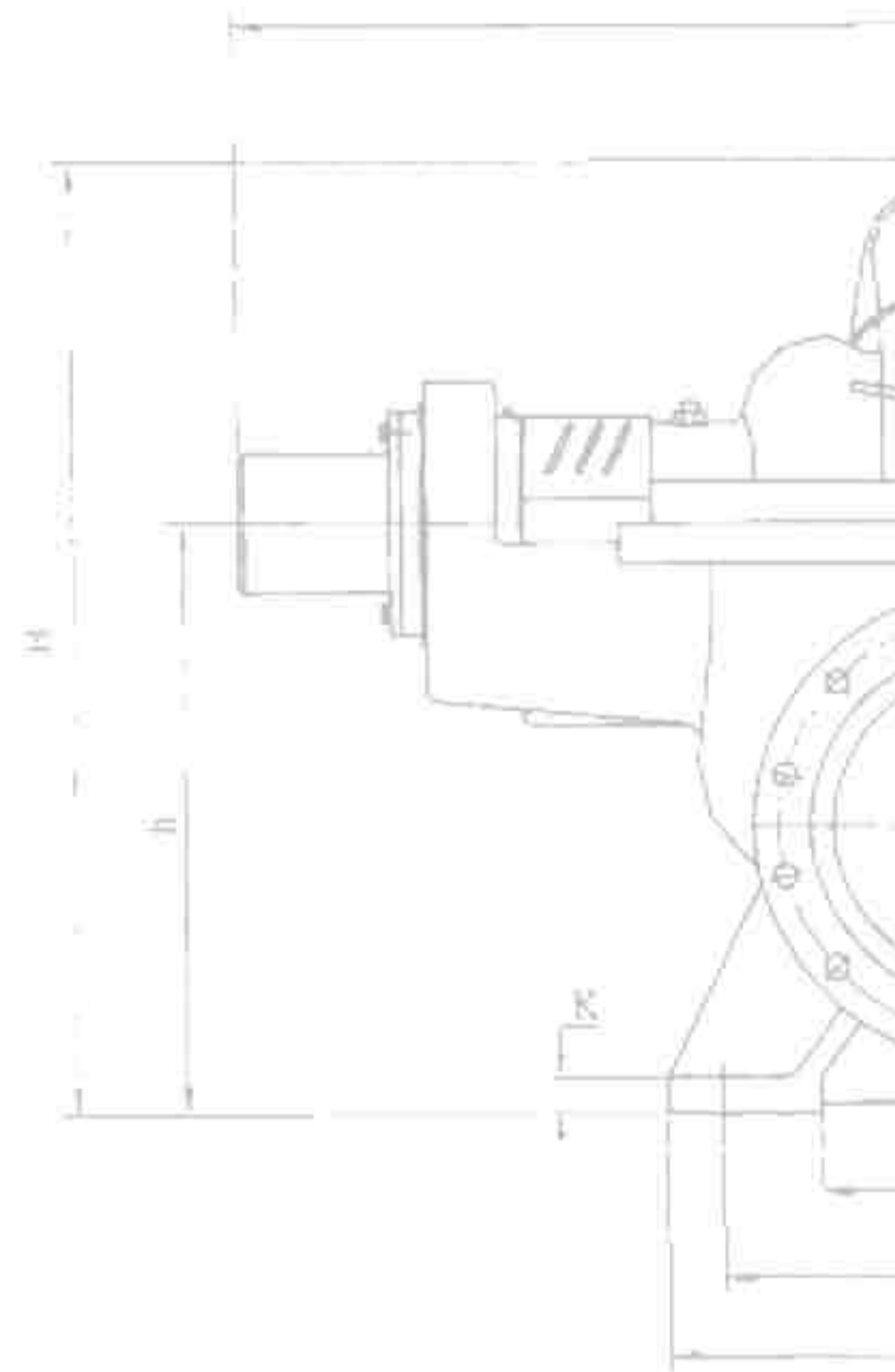

Note: The information provided on these pages is for guidance only. ITT Industries accepts no responsibility for the misuse or misapplication of this information. All specifications are subject to change without notice.

Singapore

ITT Fluid Technology Asia Pacific
298 Tiong Bahru Road
#03-05 Central Plaza
Singapore 168730
Tel: 65-6276 3693
Fax: 65-6276 3685

Philippines

Goulds Pumps (N.Y.), Inc
12 Ring Road, LISP 11
Calamba,
Laguna 4027
Tel: 63-49-545 6810
Fax: 63-49-545 6817

Australia

ITT Fluid Technology International
(Australia) Pty Ltd
18 Commercial Drive
Dandenong South, Vic 3175
Tel: 61-3-9706 5066
Fax: 61-3-9706 6065

Goulds Pumps



ITT Industries
Engineered for life